

A black and white photograph of tall, thin grasses, possibly coastal grasses, with a central white rectangular box containing text. The grasses are in sharp focus, with some blades crossing each other, creating a sense of depth and texture. The background is a soft, out-of-focus grey.

GROUNDWORK

A HANDBOOK FOR SMALL-SCALE EROSION CONTROL IN COASTAL CALIFORNIA

GROUNDWORK:

A HANDBOOK FOR SMALL-SCALE EROSION CONTROL IN COASTAL CALIFORNIA

2nd Edition

*Marin Resource Conservation District
Marin County Stormwater Pollution Prevention Program*

Groundwork was first written in 1987 through a grant from the State Coastal Conservancy to the Marin Resource Conservation District. This revision has been largely funded by Marin County Stormwater Pollution Prevention Program and a grant from the State Water Resources Control Board to the Marin County Department of Public Works. Additional funds were generously provided by the Marin Community Foundation, North Coast Resource Conservation and Development Council, and from Marin Municipal Water District funds through the State Water Resources Control Board.

We thank the following reviewers for their thoughtful assistance:

Leslie Ferguson, San Francisco Bay Regional Water Quality
Control Board
Liz Lewis, Marin County Department of Public Works
Mischon Martin, Marin County Open Space District
Ruth Pratt, Marin County Department of Public Works
Nancy Scolari, Marin Resource Conservation District

Writing: Liza Prunuske, Chris Choo, Mike Jensen and Harold Appleton of Prunuske Chatham, Inc.

Design and Cover: Lisa Krieshok, www.krieshok.com

Technical Drawings: Mike Jensen, Maggie Young, Liza Prunuske

Other Illustrations: Lisa Krieshok, Susan Pinkerton

Cover photo by Brock Dolman, www.oaecwater.org

This handbook, in both its first incarnation and this revision, is a collective creation. We are deeply grateful to everyone who contributed—the practitioners who tried and improved many of the techniques, the landowners and agencies who encouraged experimentation, and all who worked to revive *Groundwork*. This revision is dedicated to Don McIsaac, George Flanders and Leo Cronin, who each in his own way, helped keep the coho returning to Lagunitas Creek.



TABLE OF CONTENTS

1. Soil, Erosion and Sediment.....	1
2. Healing Erosion: General Guidelines.....	4
3. Channel Erosion	6
4. Gullies	26
5. Using Plants to Prevent and Repair Erosion	40
6. Roadways.....	47
7. New Construction	53
8. Livestock and Erosion	59
9. Landslides	64
10. Wildlife	65
11. Maintenance and Monitoring	67
12. Permits	69
13. Where to Get More Help.....	73



SOIL, EROSION AND SEDIMENT

Soil is more than that brown mud the dog tracks into the house after a rainstorm; it is an intricate ensemble of living microorganisms, **humus** (partially and completely decayed organic matter) and inorganic particles worn down from parent rocks. The process from rock to soil is a slow one. An average inch of topsoil, richest of the soil layers in organic matter and the creatures that decompose such material, takes a thousand years or more to form.

As any home gardener knows, soils vary widely in fertility, mineral content, physical structure and the way they react to wind and water. Some soils drain slowly, making them poor choices for unsurfaced roads or septic systems. Others are highly erodible, and the smallest disturbance can lead to a gully or streambank washout. The type and depth of soil play a major role in determining what kind of plants grow in an area. The plant community in turn affects what species of fish and other animals, both domestic and wild, can survive there.

Erosion is a natural process. It shapes our hillsides, valleys, rivers and streams; it creates fertile floodplains and it helps distribute nutrients throughout the watershed. Erosion provides necessary sediments to creeks and rivers and allows them to create a rich variety of habitats such as spawning gravels, deep pools and sandbars where new vegetation can take hold. Erosion in upper watersheds is needed to form our coastal beaches.

In stable watersheds, the rate of erosion is slow and in balance with natural restorative cycles. But in many watersheds, human use of the land has accelerated the rate of change beyond nature's short-term healing capabilities—in some places even beyond long-term recovery. The desertification process occurring in many arid and sub-arid regions is a dramatic example of how human-induced changes in vegetation and soil can lead to wide-scale ecologic and economic collapse.



KEY TO EROSION CONTROL PRACTICES



Try these yourself. These techniques are relatively simple with little risk of causing unintended, significant damage. Under most circumstances, they do not require permits. However if threatened or endangered species are present, contact your city or county planning department, the local Natural Resource Conservation District office, or the California Department of Fish and Game (Chapters 12 and 13) just to make sure your action won't cause harm.



These techniques require careful planning, but can be installed without professional assistance in some situations. We try to describe when permits are needed and the limits of safe use with each practice or group of practices. Seek professional help whenever a building, utility or road is threatened. The box in Chapter 3 has more information on when you need a registered professional designer.



This group requires engineered designs and in most cases, permits from multiple agencies. We provide only a general description of these methods.

The effects of soil erosion are not limited to the site where the soil was lost. The detached soil, called **sediment**, enters the water system and settles out—at a culvert inlet, in a stream channel, in a lake or an estuary. Some sediment is needed to enrich and create aquatic ecosystems, but too much sediment is destructive. In much of coastal California, erosion and sedimentation have been major culprits in the decline of coho salmon and steelhead trout. Fine soil particles fill in spawning gravels, reduce oxygen levels, and cement stream bottoms into uniform surfaces that no longer provide nooks and crannies to shelter young fish and the aquatic animals they eat. Larger material settles in pools so that fish no longer have deep, cool water for summer shelter. Excessive sedimentation has changed the natural functioning of bays and estuaries up and down the California coast.

Climate changes within the next twenty years are predicted to increase the frequency and severity of winter storms which in turn will likely lead to higher rates of erosion. As more stress is put on the environment, high quality habitat will become even more critical for the survival of steelhead, salmon and many other aquatic species. Repairing and preventing erosion now may save dollars and diversity in the future.

Although individual erosion problems may seem too small to fill in a bay or threaten a whole species, together they contribute vast amounts of sediment to our waterways. The purpose of this handbook is twofold: to help landowners and land managers better understand erosion processes, and to describe practices for repairing small-scale erosion problems common to northern coastal California. Each practice is labeled with one of the symbols shown in the box.

Five Basic Rules for Preventing Common Erosion Problems

1. **Protect bare soil surfaces.** Vegetation is the best protection because it both absorbs and uses water. Gravel, straw, wood chips and other mulches are also effective. If you use an impermeable substance, such as temporary plastic sheeting, be careful where you direct the runoff. You don't want to fix one erosion problem while creating another.
2. **Don't concentrate water flow unless absolutely necessary.** On undisturbed slopes, water percolates through soil slowly and relatively uniformly. When all the runoff from a single area is focused on one spot, such as by a culvert or a roof gutter, the natural protection of the ground surface is often not sufficient to prevent this extra flow from breaking through to bare soil. If you must focus runoff, protect the outflow area with an energy dissipator, such as rock or securely anchored brush, that will withstand stormflows.
3. **Limit livestock and human use of vulnerable areas.** Livestock and people can exacerbate mild erosion by disturbing vegetation and creating trails that channel the flow. Stream areas, steep or fill slopes, winter swales, unsurfaced roads, old landslides and any sites that show signs of recent soil loss are areas of special concern.
4. **Disturb existing vegetation as little as possible.** Plants hold topsoil and often subsoil in place with their roots, regulate the speed of water flowing through and over soil, and provide cover and food for wildlife. The native plant community is especially well adapted to specific soil and rainfall conditions. Once native plant cover is disturbed, the soil below becomes much more susceptible to erosion.
5. **Encourage infiltration.** The more water you can keep in the soil instead of on top of it, the less erosion you'll have. Percolation through vegetation and soil also cleans nutrients and other pollutants from water, and increases soil fertility and moisture content. Use permeable pavements instead of concrete or asphalt. Collect and spread runoff from roofs or paddocks. Plant native trees and shrubs not just along creeks, but in upland areas as well. See Chapter 7 for ways to increase infiltration on your property.



HEALING EROSION: GENERAL GUIDELINES

Most coastal California erosion problems share the common ingredients of exposed soil, flowing water and an agent, usually human or climatic, that disrupted a pre-existing equilibrium. The following guidelines will help you understand and repair all common erosion problems:

1. Watch the problem and try to determine the cause. The most essential tools for erosion control in northern California are a pair of rubber boots and a good rainsuit. The action happens during the rains. You can see firsthand how problems develop and grow, and you can catch little things before they become catastrophes.
2. Keep in mind stormflow. As you plan or execute a repair, especially during the dry season, stand back and visualize what will happen during a heavy storm. Will water shoot out beyond the rock you've placed under your culvert? Will it eddy around your brush mattress and cut a new hole in the streambank?
3. Work very carefully. Flowing water is not forgiving. It finds the tiniest crack and undermines the best intentions. Good craftsmanship creates durability as well as beauty.
4. Be patient. Every site is unique, and it may take years of observation and modification to fine-tune a repair to fit the problem precisely.
5. Be creative. For example, sometimes a handful of leaves works better than a truckload of gravel to seal a small checkdam. Be careful, though, not to add toxins or garbage to the watershed or to create a new problem downstream.
6. Work with nature. The best repairs disappear over time. You want to nudge the natural healing process, not fight it. A willow repair won't thrive, for example, under a redwood canopy. Sloping a

vertical streambank back to a more gradual, stable slope may take more room, but in the end require much less cost and maintenance than building a retaining wall.

7. Coordinate with your neighbors, especially if you are tackling streambank erosion. Erosion and the processes that create it rarely stop at property boundaries.
8. Obtain the proper permits. County, state and federal agencies have regulatory roles over most structural repair in stream channels. If threatened or endangered species are present, additional agencies may become involved. Road repairs or other grading activities may require county permits. Coastal zone work comes under the auspices of the Coastal Commission. Local zoning and ordinances restrict activities that can occur along streams. Chapter 12 has more information on permits and other environmental compliance regulations.





CHANNEL EROSION

Stream systems consist of the water and sediment flowing through them, the channel and its floodplain, and the community of plants and animals living in and next to the water. The climate, topography, soil, plants and land use of the stream's watershed together determine the stream's **morphology**, or form, and behavior. Stream morphology includes: 1) **dimension**—the shape of the stream in cross section, 2) **pattern**—the configuration of the stream in plan view as if you were looking down at it from an airplane, 3) and **profile**—the stream slope or drop in elevation.

Streams are dynamic. Bank erosion, bed scour, and sediment transport and deposition are always occurring as streams adjust their morphology. A stable stream is in a state of dynamic equilibrium with small and gradual adjustments. Large changes in the watershed, major storms, for example, or increasing urbanization, can throw the system out of equilibrium. Channel adjustments, often in the form of erosion, will occur more frequently and with more severity when the stream system is out of equilibrium.

Natural disturbances such as wildfire, floods or landslides can add vast quantities of sediment into stream systems. Human uses, both current and historic, also contribute extra sediment and change the amount and timing of water entering streams and rivers. Parking lots and roofs, for example, can cause storm water to drain into waterbodies much faster than it did when the rain fell on grass and forests. Streams often adjust to this sudden change by cutting deeper (**downcutting**) or flooding. However, even a stream in balance with its sediment load and water inputs will slowly change its shape as sediment moves downstream. Unless it is solid rock, what appears to be a stable bank will, at some point, move.

The channel evolution model shown helps explain how channels change over time after disturbances to their dynamic equilibrium.

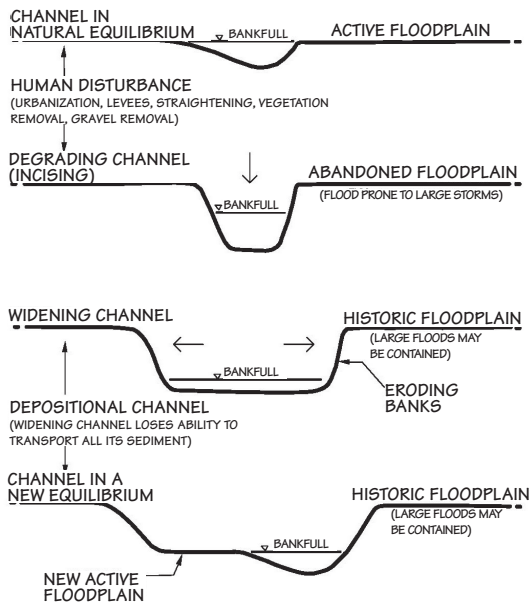

Channel evolution model

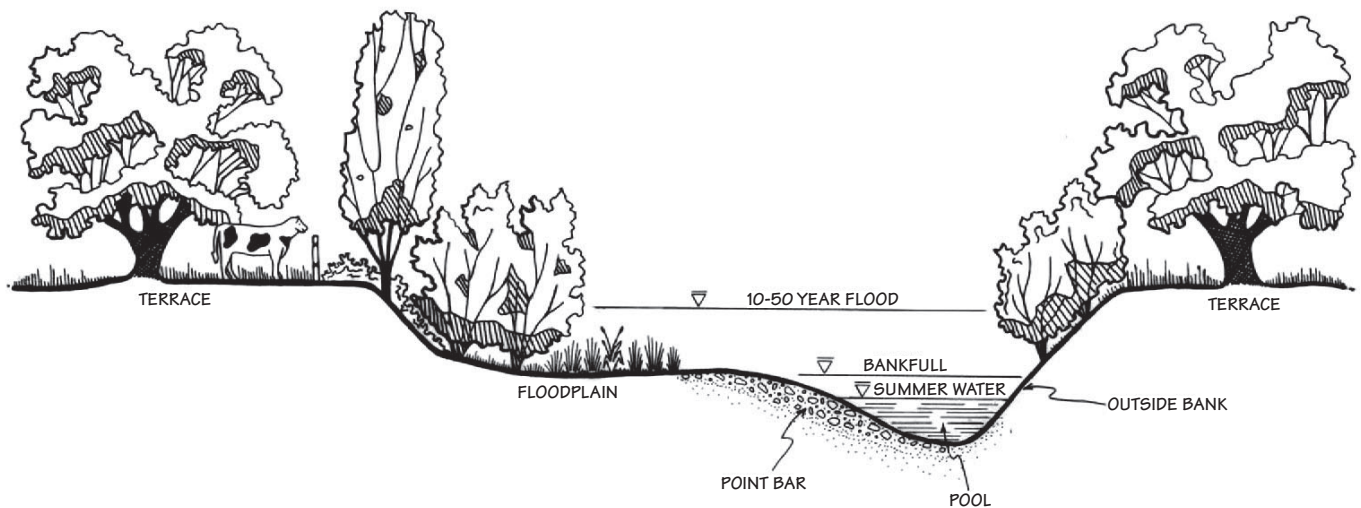

Stream dimension (section view) showing stream section 'A' from plan view.

Before undertaking a major restoration project along your reach of stream or river, it is important to determine what stage of evolution your reach is in and what you can expect over the next ten or twenty years. Several of the references listed in Chapter 13 under River Science and Management describe channel evolution in depth. River scientists in private restoration firms and in many public agencies can also advise you.

A stream's basic shape is maintained by high frequency, storms that occur approximately every 1.5 years. These storm events are referred to as **bankfull**, or channel forming, flow. The pools, riffles, and undercut banks critical for the survival of fish and many other aquatic species are maintained through the bankfull flows and the erosion and deposition they cause. Stream terraces and floodplains are created by larger and less frequent storms. These features provide room for water to spread out and slow down during high flow events, as well as serve as some of the most important habitat for California's native birds and other wildlife.

Streams are classified as perennial, intermittent, and ephemeral. **Perennial** streams flow all year. **Intermittent** streams flow during the wet season and dry up for at least part of the summer. **Ephemeral**

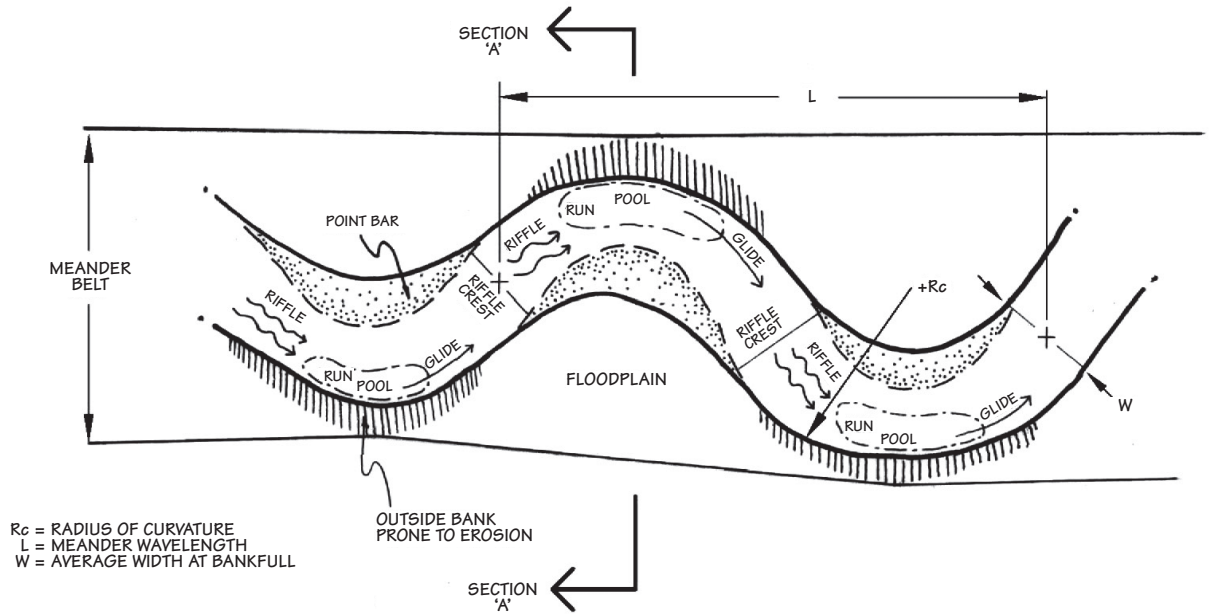

Stream pattern (plan view)

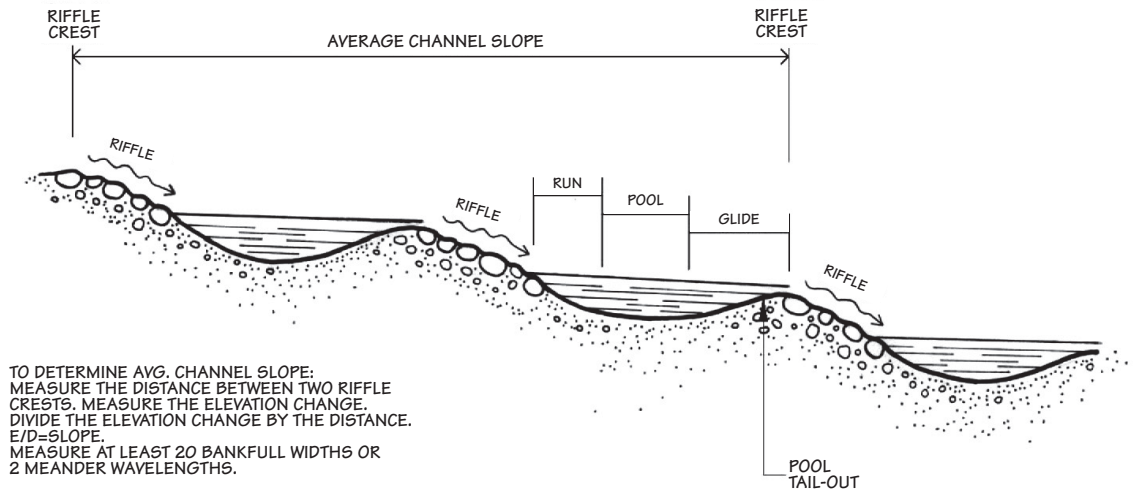

Stream profile

streams have surface flow only immediately after winter storms and in some dry winters may not flow at all. A **swale** is a depression that moves water during rainfall, but unlike a stream, it moves little or no sediment. Swales are commonly covered with grass or forest duff.

Gullies are channels that have cut into unprotected soil, creating severe, accelerated erosion. They can form in swales or ephemeral streams that have been overwhelmed by concentrated runoff. Gullies are characterized by their rapid and excessive downcutting. Unprotected culverts and poorly designed roads often cause gullies. Many of the techniques used to repair eroding stream channels also apply to gullies. Chapter 4 covers practices specific to gully stabilization, and Chapter 6 addresses road erosion.

Once they leave their steep upper tributaries, streams and rivers curve through their floodplains in meanders. In a system in balance, the width of the **meander belt** remains approximately constant, even though the meanders themselves move downstream over time as soil on the outside curves is eroded and then deposited downstream. This is a handy concept to understand when building a riparian fence, for example, or planting grapes or vegetables. Keeping them outside the meander belt gives them a much better chance of staying where you put them.

Sinuosity is a measure of the stream's length divided by the valley length. The greater the sinuosity, the curvier the stream.

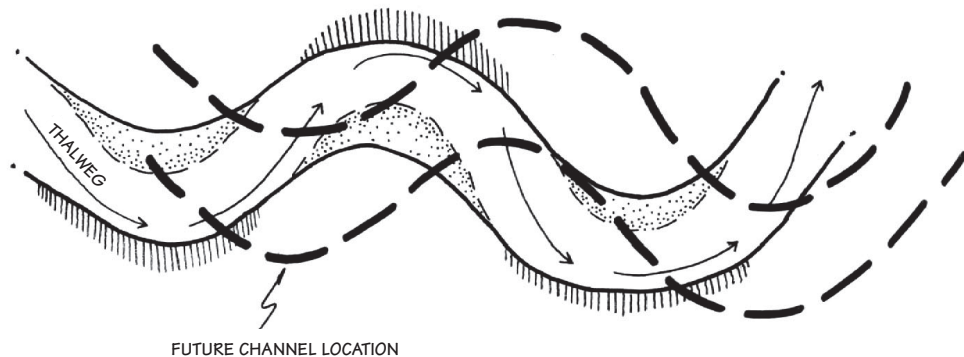

Channel migration

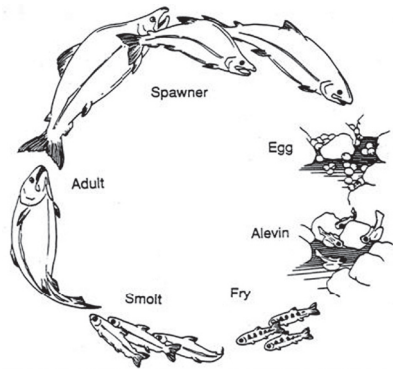

Salmonid life cycle. Courtesy of Santa Cruz County Resource Conservation District

Preserving fish passage

Anadromous fish, such as steelhead trout and salmon, spawn in fresh water and mature in salt water. At key points in their life cycles, they need to move up and down stream channels. In winter adult fish leave the ocean to swim into the tributaries and upper mainstem reaches to spawn. The timing of the adult migration varies geographically, but in Marin County's coastal streams, coho usually spawn from November through January and steelhead from January through March. After one full year in the stream for coho, and one to two years for steelhead, most of the young fish migrate back out to the ocean in the spring. Before they leave, juvenile fish need to move up and down the stream to find food, cover and deep pools. Erosion repairs in streams with anadromous fish must allow fish to move freely during all stages of their lives.

Woody debris and erosion

Although downed trees and piles of branches can force streamflow into banks and cause erosion, they are vital for healthy streams. Fallen trees and branches, also known as **large woody debris** or **LWD**, trap sediments for spawning gravels and nutrients to feed the aquatic insects that form the foundation of a stream's food web. They create pools, shade and hiding places for fish, and perches for birds and turtles. In a 1996 report on the decline of salmon populations, the National Research Council stated "perhaps no other structural component of the environment is as important to salmon habitat as large woody debris." During the summer, woody debris jams may appear to block fish passage, but this is actually rarely the case. In winter high flows, fish can usually swim over or under the wood. Even in low flows, fish are skillful at navigating through most piles.



Wood in streams is regulated by the California Department of Fish and Game (CDFG). If you are concerned about erosion or genuine obstruction of fish movement, contact CDFG before you start moving the wood. (See Chapter 12 for contact information.) Remember that erosion is a natural part of a healthy stream. If no structures or roads are threatened, the benefits of the wood in the stream may well outweigh the risk of erosion damage. If property is threatened, consider altering the wood to reduce the risk while maintaining some habitat benefits. Exposed branches from fallen trees can be trimmed while

leaving the main trunk and root wad intact. Moving logs so that they are more parallel to the streambank will help focus flow away from vulnerable banks and prevent the downed wood from collecting more debris. See References #11 and #48 for more information on how to preserve fish habitat while moving LWD.

Treating Channel Erosion

Chronic, severe streambank erosion indicates a major imbalance within the watershed. Treating the symptoms may save one section of streambank, but it might just move the problem to a neighbor. Many watersheds have plans or studies that evaluate habitat issues and erosion processes for entire streams or stream reaches. These plans can be very helpful in giving individual landowners a context in which to select a repair with the best chance of satisfactory long-term results. Check with your county planning department or Resource Conservation District for information about your stream. Often, watershed plans and studies also help landowners access grant funding or design and permitting assistance. Consider joining forces with your neighbors to tackle streambank erosion with a coordinated strategy.

In this section, we will present three types of repair techniques as described in the introduction. The first group includes methods that landowners can use themselves safely in most conditions. Techniques in the second group can be used without professional help to stabilize relatively minor streambank erosion sites (3 feet high or less and 15 feet long or less) that are not immediate emergencies and where there is little or no danger of property or habitat damage should the repair fail. If in doubt, contact the Department of Fish and Game, your local Resource Conservation District, or your county or city stream expert.

The third group covers stabilization methods used for severe erosion, where property is threatened, or where changes in the stream could cause damage to neighboring land or important habitat. The methods in this group almost always require engineered designs to fit the specific conditions of your site and to meet regulatory requirements.

Before you get started on your stream repair effort, here are two important questions to ask yourself:

Is the problem urgent? Many streambank erosion sites heal themselves as the creek adjusts to watershed changes. Sometimes the best course



Try yourself



Can be used by the layperson under the circumstances described



Requires professional design and installation

WHEN DO YOU NEED A REGISTERED PROFESSIONAL DESIGNER?

Registered professional designers include engineering geologists, geotechnical engineers, civil engineers and landscape architects. They are licensed to practice in special areas of expertise, but any of them should be able to direct you to the one best suited to help you. They are needed:

- If a building or other important utilities and infrastructure (such as a road or septic system) are threatened.
- To get a grading permit or creek permit from many counties and cities.
- If you need to build retaining walls higher than 3 or 4 feet depending on the local building code.
- If you need to move more than a few wheelbarrow loads of soil or rock to stabilize your streambank.
- If fill is required in the active stream channel.

Fluvial geomorphologists and hydrologists are scientists who study the processes of river formation. They can also help design sound erosion control and restoration projects.

of action is to watch your site over a winter or two. However, if there is any chance that safety, roads or important structures are at risk, get help immediately. Getting a project designed with permits in place and built before the rainy season starts often takes six months to a year.

What is causing the erosion? Has a newly formed sediment bar or fallen tree shifted the main flow of the stream over to your bank? Is the whole channel deeper with banks on both sides slumping into the creek? Does surface runoff, maybe excess water from your lawn or stormflow from a driveway or roof downspout, cause or exacerbate the erosion? It's not always easy to tell the root cause, and you may need help from an engineer or restoration specialist. As the landowner or resident, however, you can contribute vital information on how your property has changed over time.

Once you understand the cause and have determined that you need to take action, you can begin selecting a repair strategy. Remember that streams are highly regulated by federal, state and local agencies. Check Chapter 12 for regulations that apply to your project.

Channel erosion on the outside curve

Sediment in a streambed is deposited where the gradient flattens out (where the stream becomes less steep) or where rocks, roots or some other mass slows the flow. In a typical scenario, the main line of flow, called the **thalweg**, moves to one side of the sediment buildup or point bar and cuts into the opposite bank. As more sediment is added from upstream erosion, the flow further erodes the outside bank, which in turn adds even more sediment. Obstructions such as fallen trees or improperly designed bank repairs can also change the thalweg and divert it directly into streambanks.

Solutions to address meander-related erosion in the stream include protecting the bank, deflecting the flow away from the erosion, or re-aligning the curve. All can have serious side effects and should be carefully evaluated. As water cuts the outside bank, it expends energy. If it can't cut there, it may cut somewhere else—either on a downstream bank, or in the case of channel straightening, in the bottom of the channel causing widespread bank failure.

Studying a **reference stream reach** can help with selecting and designing an appropriate repair. Reference reaches are stable lengths of channel

in the same or a neighboring watershed that have similar characteristics as the problem area. They have the same average rainfall. They are located in about the same position in the watershed—both in the lower, flatter parts of the watershed, for example, instead of one in the valley and one up in a steep tributary. They are similar in size and carry about the same amount of flow. They run through the same kind of soil or parent material. Reference reaches can show you how your channel could look, at what angle the banks are stable, what kind of plants thrive there, and what size rocks or smaller sediment cover the channel bottom. In designing a streambank repair, reference reaches are used primarily to determine the appropriate channel geometry for your site.

1. Protecting eroding banks

Three types of bank protection can be used to protect eroding streambanks: vegetation by itself, bioengineering, and armoring with hard surfaces. Vegetation alone is only effective on very gentle slopes with slow moving water. Chapter 5 contains specifications for seeding and planting. Traditional hard armoring methods, such as rock riprap and walls made of concrete, gabions or other non-organic materials, frequently cause other problems. Such methods fix a stream channel in place and do not let it respond to future changes in its watershed. They can also exacerbate downstream erosion and flooding. Instead of being slowed by tree roots and boulders, storm flows speed past hard, smooth surfaces with more erosive force. Hard armoring significantly reduces habitat values for fish and other aquatic and riparian wildlife. Failure rates of solid impermeable repairs can be high as water pressure builds up behind the structure. In recognition of these issues, permitting agencies have been less willing to approve hard armoring techniques than they have in the past.

Bioengineering methods incorporate structural repairs with vegetation. When they work well, they disappear into the riparian habitat within a few years. They use materials that either degrade, such as coconut fiber mats, or are natural to the stream, such as native plants, logs and rock. They add wildlife habitat value by increasing cover and shade in the stream channel, and providing food and shelter for the animals that use the stream corridor. Some bioengineering repairs are relatively straightforward for small-scale streambank erosion. Check the box earlier in the chapter to see if you need an expert.

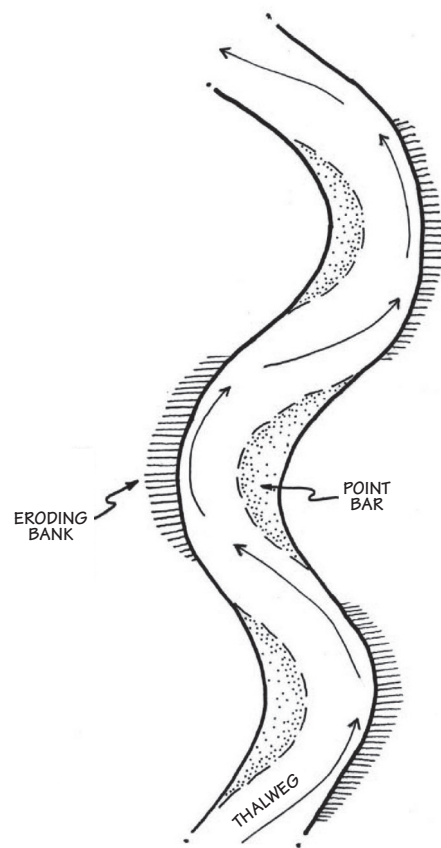

Channel erosion, plan view



Tree roots protecting a bank and creating habitat.



Willow sprig

Many of the following bioengineering techniques utilize willows. Willows are the backbone of many coastal California ecosystems and are often the first woody plant to colonize disturbed areas. They root easily and once established can survive high flows. They do need sun to thrive, so don't try a willow-based repair in a deeply shaded red-wood reach. All willow cuttings should be collected and planted when the plant is dormant, usually from late September through December. In order to beat the winter flows, October and early November are the best times to install bioengineering repairs.

We recommend using wood stakes and manila rope (a natural fiber) whenever staking and binding are called for, instead of rebar and nylon rope or wire. Natural materials will degrade over time, and will not strangle growing plants or cause serious injury to people or animals. When bioengineering techniques are used near the top of a streambank or on dry slopes, drip irrigation may be required for the first two to three years to firmly establish plant growth.

The following repair methods are arranged in order of complexity. The first group can be used without professional design at most sites. Always consult a professional designer if any of the conditions identified in the box titled "When do you need a registered professional designer?" exist.



Willow sprigs are simply sturdy willow cuttings planted directly into the ground. Chapter 5 describes planting details and gives guidelines for deciding if willow is the right plant for your streambank. Willow poles are longer, stouter cuttings that can be driven deeper into the bank to withstand high flows or secure other structures, such as willow walls.



Wattles or **live fascines** are bundles of live cuttings, usually willow, bound together by rope. They can be staked by themselves in shallow trenches along the contour, or used in concert with other bioengineering techniques for toe stabilization. Willow wattles lend themselves beautifully to volunteer efforts and are easier to assemble when many hands, even very small ones, help.

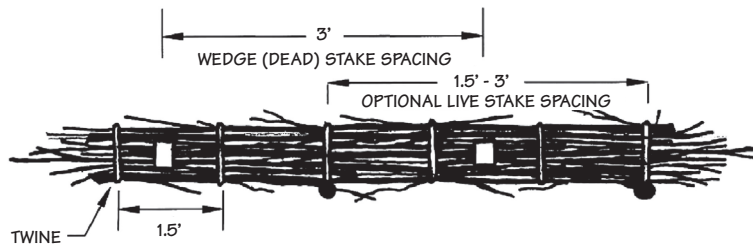

TOP VIEW

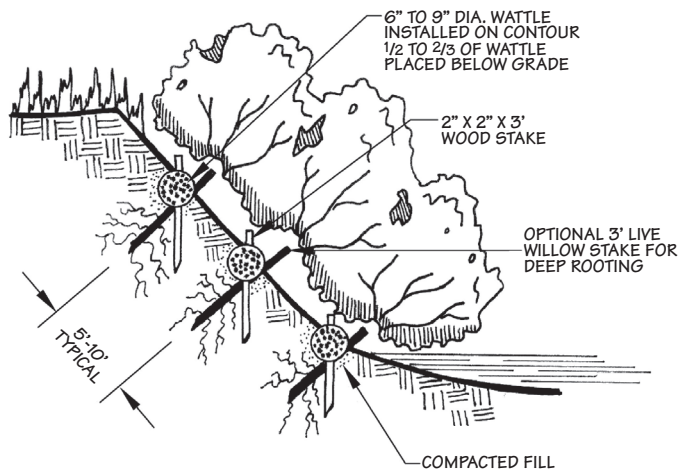

NOTE:
BLANKET OR MULCH CAN
BE USED W/SEED IN
BETWEEN WATTLES.

SECTION

Series of willow wattles on slope

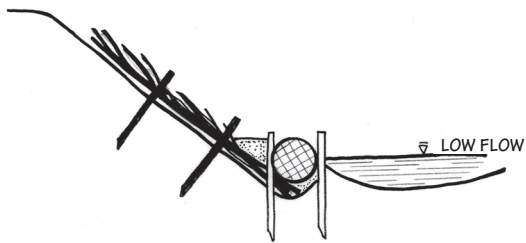

BRUSH MATTRESS WITH
COIR LOG TOE

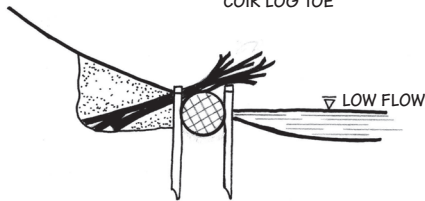

COIR LOG WITH
BRUSH LAYERING

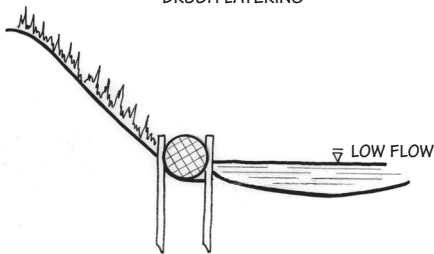

COIR LOG TOE PROTECTION

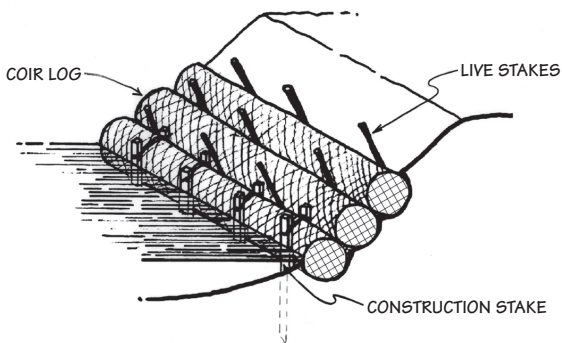

Coir log revetment with live willow staking



Coir logs are manufactured cylinders of tough coconut fiber that come in different lengths and diameters. They are commonly used at construction sites to slow runoff and trap sediment. Coir logs can be stacked and staked to provide protection in low-flow channels at the toe of banks or on gentle slopes. Willow sprigs make excellent stakes in sunny sites. Make sure that the logs are very securely staked to withstand high velocities. If they get loose in the stream, they can damage wildlife and divert flow.

The next group of techniques may be built by the layperson under the specified conditions. However, we recommend that you consult with National Resource Conservation Service (NRCS), your local Resource Conservation District (RCD), County staff trained in biotechnical repairs, or a restoration consultant before you design and install these repairs. Because these structures will be exposed to high velocities and strong erosive forces, improper placement or inadequate keying into the bank can easily create worse problems than you started out to fix. Unless fill, such as rock, is added below the ordinary high water mark (active channel or bankfull depth), permits from the Army Corps of Engineers are not necessary. However, a permit from the California Department of Fish and Game (CDFG) is needed when working from the bed of the stream through the riparian habitat along the stream-bank. Other permits may also be required, especially if threatened or endangered species are present (Chapter 12).



A **brush mattress** is a dense layer of branches that is staked and firmly secured with rope. The butt ends of the brush are placed in a toe trench where they can be protected by coir logs or willow wattles. If willow branches are used and the site has sufficient moisture and sunlight, the branches will sprout. In shady areas, the mattress can be made with any brush and then interplanted with shade tolerant trees and shrubs. Use brush mattresses on banks with slopes no greater than 2:1 (2 feet in horizontal run for every 1 foot of vertical rise). If you think you need rock to protect the toe, seek professional advice. Remember that using rock in the channel may also increase the number and complexity of permits required.



Brush mattress

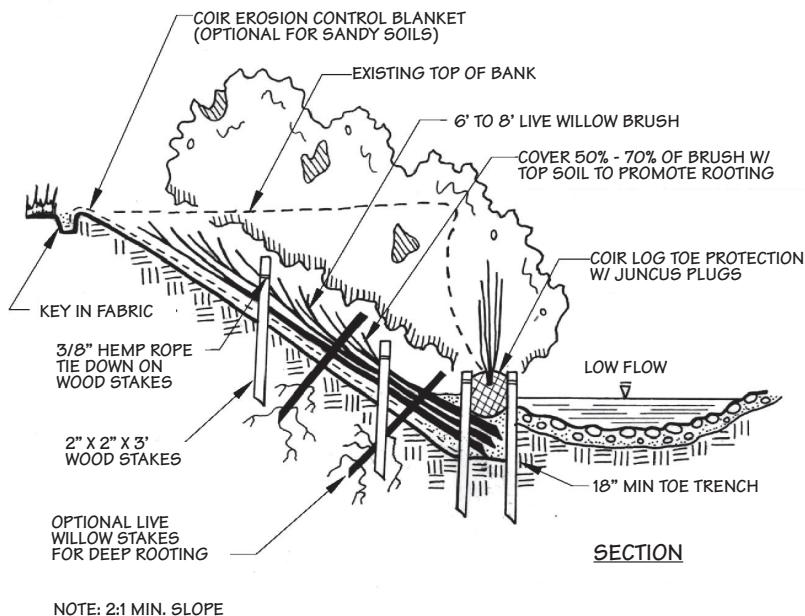

Brush mattress, section view

THE KEY TO SUCCESS IS THE KEY.

When planning a streambank project, careful consideration must be taken to properly keying in or securing the upstream and downstream ends of the repair. The key will prevent the project from unraveling or being scoured out during the first big storm. The diagram shows the following key considerations and alternatives:

1. Begin streambank projects upstream of the point where the thalweg meets and runs along the outside bank.
2. Look for existing stable stream features such as rootwads, logs or large boulders to key the project into.
3. Key willow walls, coir logs, wattles and other structures into the bank by digging a small keyway trench at both the upstream and downstream ends. The trench should be sized for a snug fit. Consider installing extra willow sprigs or poles in these locations to provide deep roots and additional anchors for securing the structure.
4. Extend projects downstream of the point where the thalweg begins to cross over to the opposite bank. This varies by stream size, but 10 to 25 feet is common.
5. If a suitable area for a key is not present, installation of a few large boulders into the toe of the bank or the engineered placement of a rootwad with stem can provide good keys for most bioengineering techniques. Remember that adding fill in the active channel, such as rock or a rootwad, will increase the need for permits and professional assistance.
6. A favorite key technique is to tuck biotechnical repairs behind existing trees that have large, stable root masses.

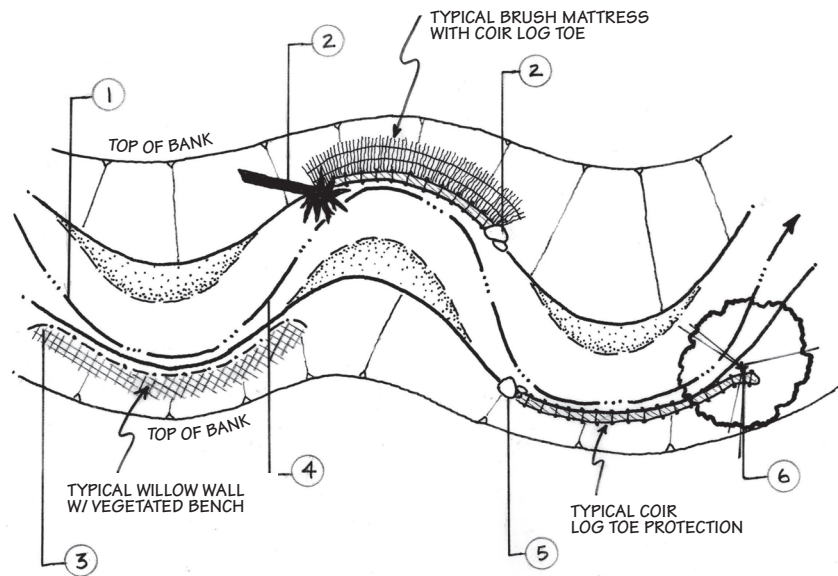



Willow walls are living retaining walls. Willow poles are driven into the ground and long willow branches are woven tightly between them. A natural fiber erosion control blanket and/or a layer of small brush is packed behind the wall, and the wall is then backfilled with soil. As with brush mattresses, the toe is often protected with a coir log, wattles, brush layering or loose rock. Both the poles and the woven branches sprout to form a dense willow thicket. Typically, you can use willow walls without professional design if the repair is only one wall high, if the height of the wall does not exceed 30 inches, and if you are able to securely key in the structure to existing stream features, such as trees. Get professional help if you need a series of walls, higher walls, or for any repair requiring rock at the toe or complex key installation.



Willow walls

NOTE: SEED & MULCH ALL DISTURBED AREAS

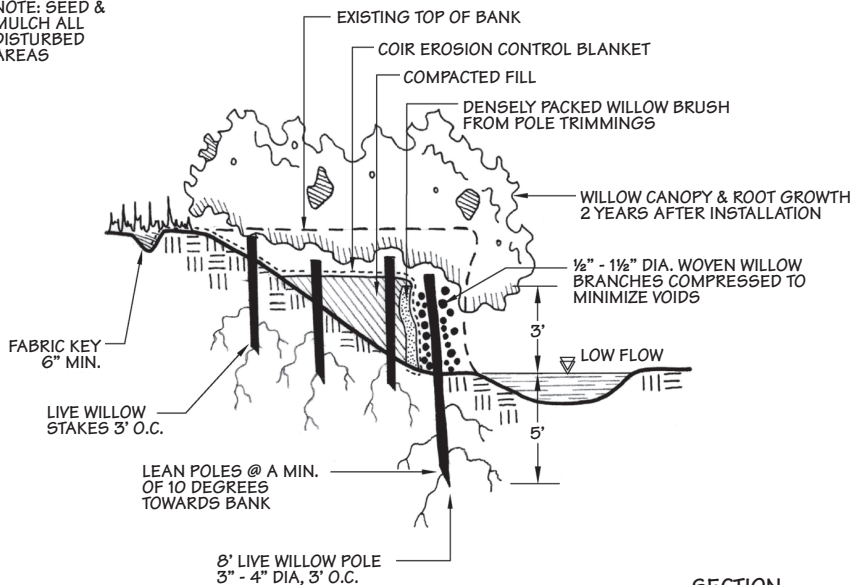

SECTION

Willow wall, section view

The following techniques require professional design and usually require construction with heavy equipment. Because they use fill within the stream channel, they also require the full range of stream permits.



Brush layering is used on cut and fill slopes, and to repair small slumps caused by seeps. Layers of brush are placed perpendicular to the slope's contour in benches carved into the face of the cut slope or between lifts of compacted fill. The tips of the brush extend approximately 18 inches past the surface of the slope where they trap sediment and slow runoff. As the brush grows, the roots hold the soil in place. Although willows are often used for brush layering, other live woody cuttings such as dogwood (*Cornus sericea*), ninebark (*Physocarpus capitatus*) and cottonwood (*Populus spp.*) also sprout.

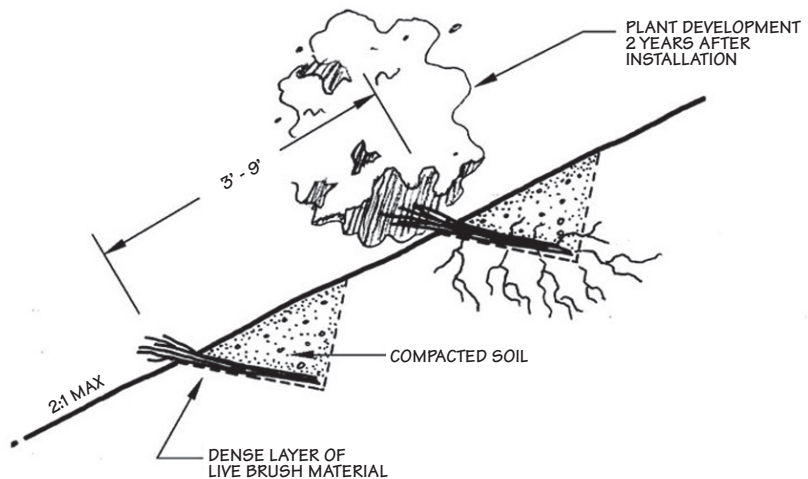

Brush layering, section view



Fabric reinforced earth fill (FREF) is one of the strongest bioengineering techniques. Similar to brush layering, FREFs consist of layers of fill interplanted with brush layers. However, the face of each soil lift is wrapped in coir mats to form a structure similar to a stack of quesadillas. The fabric encapsulates the soil to provide instant erosion protection and allows FREFs to be used in situations where they will be immediately subjected to flowing water. As the plants grow, their roots form a dense, stable matrix to create even greater protection. A FREF must be built on a stable foundation, often rock.

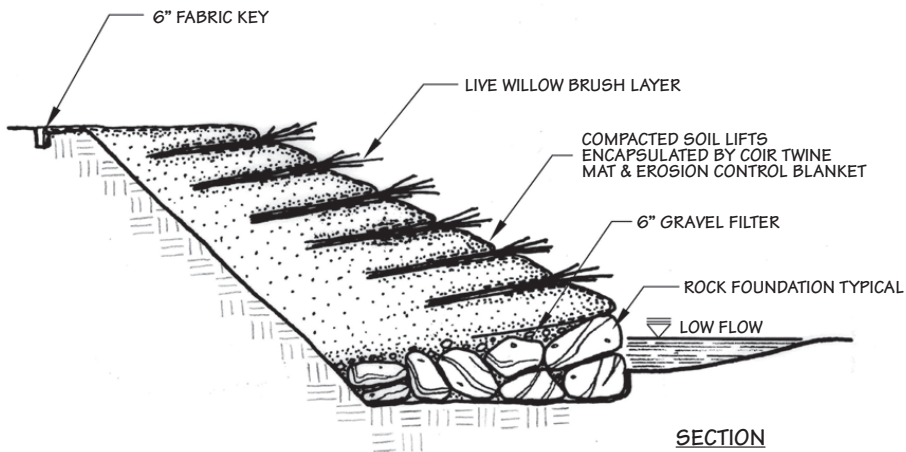

Fabric reinforced earth fill, section view



Vegetated boulder revetments combine traditional structural stabilization with vegetation. Boulders are a “hard” repair and should be used only at high risk sites where conditions preclude a successful vegetation-only solution. Sprigs, poles or rooted plants are planted in between the boulders either as the revetment is being built, or plastic pipes are inserted as place holders during construction and the plants installed when the rainy season begins. Holes between the rocks can be filled with gravel and soil to improve natural revegetation.

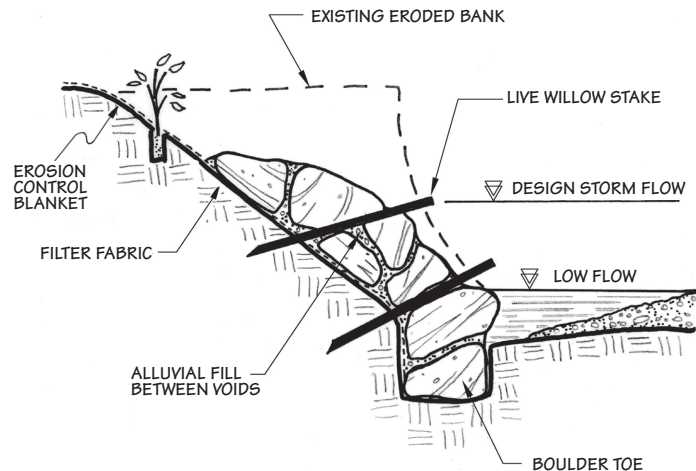

Vegetated boulder revetment, section view



Large woody debris bank protection. Repair by Wildland Hydrology.



Large woody debris (LWD), especially big root wads, can be used to protect banks and create excellent instream habitat. Correct placement is critical so that the structures stay in place and function as intended. Rock or cables are sometimes used to anchor the LWD.

2. Deflecting the Flow



Deflectors, vanes, barbs and sills are obstacles attached to one bank, extending at an angle into the channel. They steer flow away from eroding banks or slow it along the near bank. At best, they are elegant repairs that buy time for the eroding sites, trapping sediment to allow vegetation to become established and secure the bank. At worst, they can cause additional erosion by aiming flow at unprotected banks.

Deflectors can be constructed of logs, rock or even willow poles and branches. Some are designed to carve pools into the channel bottom for fish habitat. All should be securely anchored into the bank and checked frequently during the winter to make sure they are not causing unintended damage.

Because deflectors are built in the active channel, they require permits from the Army Corps of Engineers, the Regional Water Quality Control Board, and the California Department of Fish and Game. An experienced stream engineer or restoration specialist should design deflectors.



Boulder J-Vane

NOTE: THE "J" VANE REDUCES NEAR BANK SHEAR STRESSES UPSTREAM AND DOWNSTREAM OF THE STRUCTURE, MINIMIZING BANK EROSION WHILE CREATING POOL HABITAT. THE STRUCTURE MAINTAINS CHANNEL FLOW CAPACITY. ORIGINAL CONCEPT DEVELOPED BY D. ROSSGEN.

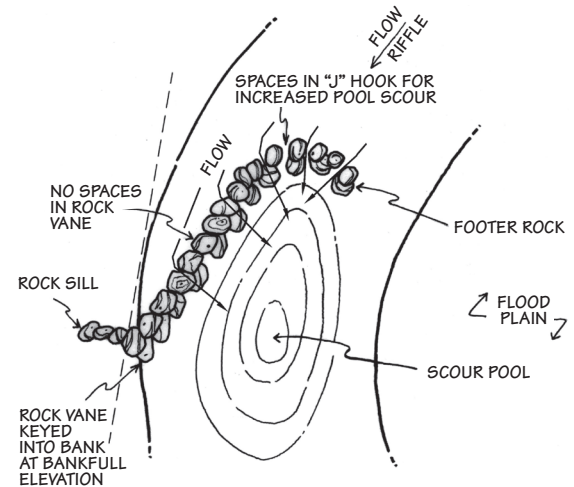

NOTE: THE PROPER INSTALLATION OF THIS STRUCTURE REQUIRES HYDROLOGIC, HYDRAULIC AND GEOMORPHIC ANALYSIS.

Boulder J-Vane, plan view

3. Realigning the Channel

Channel realignment is a major undertaking that should be done only with sound, professional advice and all the necessary permits in your pocket. Straightening a curve without careful planning is practically guaranteed to move the erosion problem just a short distance downstream and probably make it worse. The straightened reach covers the same vertical drop in elevation over a shorter distance. Like a skier heading straight down the mountain instead of curving back and forth, the flow gains in speed and erosive power.

Realignment can be a useful tool in the restoration of long stream reaches to re-establish equilibrium between flows and sediment loads. If designed well, built to sustain instream habitat elements such as pools and riffles, and followed with bank stabilization and rigorous revegetation, realignment can be very effective.

Downcutting

The laws of gravity dictate that soil and rock move downhill. Upper reaches of streams cut deeper into the hillsides, sending sediment to accumulate at the lower reaches. As with meandering, in many watersheds this natural process has been speeded up by human activity in the watershed, which increases the rate of storm runoff beyond the stream's capacity to handle it safely.

Downcutting in streams is the same process as headcut movement in a gully. Headcuts or nickpoints are abrupt changes in gradient. If the streambed is not adequately protected by bedrock or the right size of rock for the stream flow, water pouring over the nickpoint will continue to cut away the channel bottom and the nickpoint will move upstream. As the channel bottom drops, the banks slough back in order to find a stable angle. Tributaries entering the downcutting channel also begin to cut deeper. In many coastal California streams, this process causes the stream to become so deep that it is disconnected from its floodplain—even in heavy rains the flow

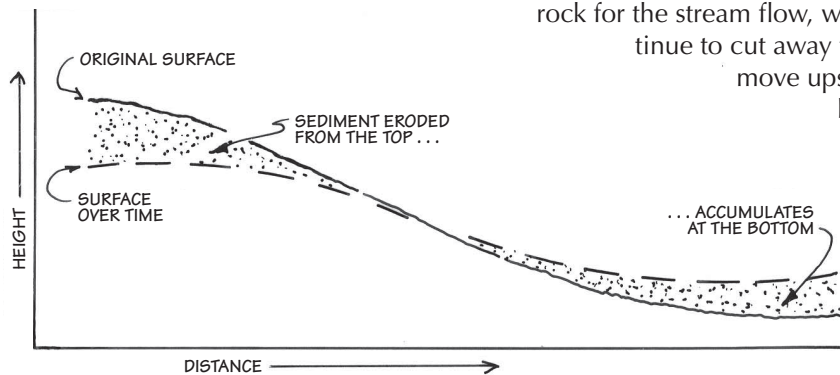

may not be able to reach the floodplain to spread out and slow down. Confined in its narrow channel, flow speeds up and cuts deeper. Riparian forests, left high and dry on the abandoned floodplain, lose vigor as the water table drops and may eventually die.



+ **Grade stabilization structures** are built to control downcutting, but their use is perilous. Unless they are very carefully designed, they can flatten channel slopes and increase upstream channel meandering. Boulder step pools, boulder weirs or roughened rock ramps are methods that allow the stream to gradually transition from one level to the next while also allowing fish and other aquatic creatures to swim up and down the structure. Because of the risk of profound changes to channel stability and habitat, all grade stabilization structures should be designed by experienced river restoration professionals.

Surface and subsurface flow

Excess surface runoff and subsurface water flowing from the land adjacent to the streambank can worsen existing bank erosion and occasionally be a primary cause. Surface runoff erodes the bank face, undermining whatever armor has been placed or planted there to protect the bank. Inordinate amounts of subsurface flow can saturate banks and make them far more vulnerable to outside-curve erosion and downcutting.

Surface and subsurface flow can usually be controlled at the source. Roofs, foundation drains, road grading and over-irrigation are common sources of excess flow. If the source cannot be eliminated, berms can trap surface flow and subsurface drains can intercept ground water before they reach vulnerable banks. Remember to redirect the captured flow to a well-protected, nonerrodible point.



A series of boulder step pools in a restored channel.

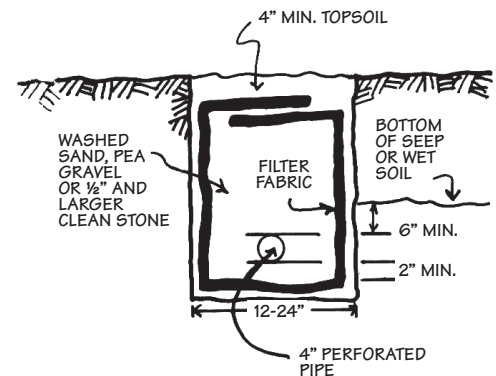

Subsurface drain



GULLIES

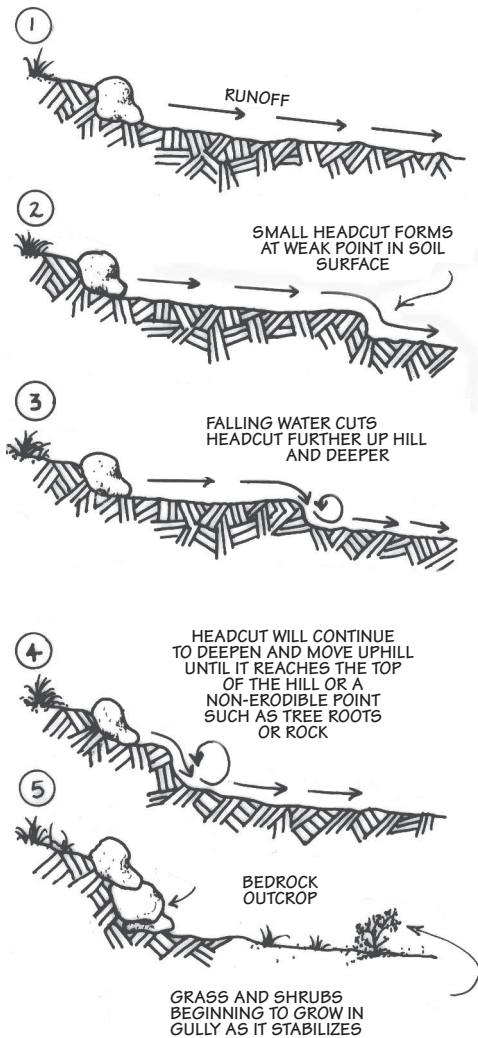

Headcut movement

Gully erosion is the accelerated downcutting of existing channels or the creation of new channels from concentrated runoff. In this handbook, we use the term **gully** to refer to newly cut hillslope channels where none existed before—below a ditch relief culvert, for example—or former swales that are now actively eroding with areas of recently exposed soil. Gullies have steep gradients and unstable bottoms. Many of the techniques described in Chapter 3 to treat streambank erosion apply to gullies.

Depending on soil type, how the gullies were caused, the amount of water flowing into them and the rate of runoff from the surrounding watershed, gullies can range in size from ruts to junior canyons. Some grow slowly while others seem to devour land, often spreading into tributary drainages as they race upslope. Because of this variability, it is important to understand some of the basic concepts of gully action so that you can tailor the repair techniques to your particular gully. What works wondrously in one can be ineffective, and frustrating, in another.

Most gullies are formed by one of two processes. The first occurs when the bottom of the stream channel downstream of the gully has been lowered. As the nickpoint moves upstream, all of the tributaries, even small swales, will cut down to meet the new base level of the downstream channel. The second process occurs when runoff is concentrated and then directed to an area that is not accustomed to handling that amount and intensity of flow. At some vulnerable point, sometimes a gopher hole or just a slightly steeper spot, the soil integrity will break down and topsoil will begin to wash away. Undersized and poorly maintained culverts are a significant cause of gully erosion in coastal California.

Gullies move upslope. The frontline is the primary **headcut**, the sharp break in slope gradient at the top of the gully. As water falls over the headcut, it continuously erodes the cut face, and the gully expands

up the hill. Some gullies have more than one primary headcut, each spreading into a subdrainage.

Secondary headcuts or **nickpoints** work within the gully by the same action, undermining the gully floor and thereby deepening the channel. Some gullies have relatively uniform bottoms, with no secondary headcuts. Others stairstep up the slope with a series of nickpoints. As gullies deepen, the toes of the banks are weakened, the banks slump down and the gullies grow wider. Deep gullies can lower the groundwater table. In rangeland, this in turn can have a profound effect on the surrounding vegetation, often making it easier for hardier weedy species to overwhelm more succulent forage plants.

Before you tackle a gully, always try to figure out what started it and what is making it worse. Does a dirt road above the gully focus water into the gully drainage? If so, your most cost-effective repair may be to modify the road drainage. (See Chapter 6.) Anything that disrupts the natural drainage pattern is a potential culprit. If most of the drainages within a watershed are gullied, then the problem may be a fundamental imbalance such as an increase in the rate of runoff due to soil compaction or a major change in vegetative cover. If feasible, it is wise to address these more fundamental problems while also treating their symptoms.

Below are steps for repairing most gullies. Descriptions of specific techniques and caveats for their use follow the steps. Remember that work in gullies may require the same permits that apply to streams (Chapter 12).

1. Try to discover why the gully formed. If possible, address the cause. Reducing flow will reduce its erosive power.
2. Stop the headcutting. Stabilizing the gully head will at least prevent the gully from lengthening.
3. Restrict livestock access if the gully is on grazing land and plant native grass and woody species wherever you can on the gully banks. Sometimes these first three steps are enough to significantly slow the erosion and allow the gully to heal. If erosion is too active to allow for plants to become established or if downcutting threatens headcut repairs, move to steps 4, 5 and 6 before planting.
4. Stop the downcutting. If active secondary headcuts within the

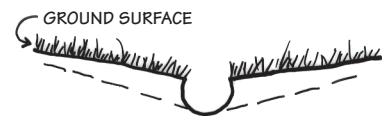

Gully impact on groundwater table

gully are not stabilized, they may creep upslope and undermine whatever work you have done upstream. Downcutting may be treated by protecting the secondary cuts just as you would the headcut and/or constructing grade stabilization structures across the floor of the gully. As we cautioned in Chapter 3, grade stabilization is tricky business. We strongly recommend that you seek experienced, professional advice before installing checkdams or grade stabilization structures.

5. Consider raising the level of the gully. Checkdams are a form of grade stabilization structure that allows sediment to settle out in the slower water above the dam. Alternately, the channel can be filled behind the structure at the time of construction. As the floor of the gully rises, the water table also rises, and the banks of the gully become shorter and more stable. Plants are able to take root because the soil stays in place instead of continually washing away. Checkdams are best used in steep (5% slope or greater), ephemeral channels.
6. Slope the banks of the gully back to a stable angle. With the headcutting and downcutting stabilized, this will usually occur naturally in time. However, sloping the banks allows vegetation to become established and speeds up the recovery process.
7. Revegetate the gully with grass seed and/or other native plants (Chapter 5). The primary purpose of the structural work is to hold the soil still long enough for plants to take over the job.

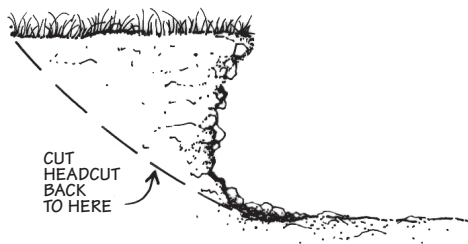

Shaping a gully headcut

Stopping the frontline: headcuts

As the fastest eroding part of the gully, headcuts are hard to stop. All the techniques listed below have been used successfully in coastal California, but they are not all appropriate for every headcut. Whatever method you use, follow the guidelines carefully and be vigilant about checking the site and repairing any damage promptly during the first two or three winters. **Get professional advice for any headcut greater than 3 feet in height or if any of the conditions identified in the Professional Designer box in Chapter 3 exist on the site.**

For most repairs, we recommend first shaping the headcut. Pulling back the headcut to an angle of repose and smoothing the soil surface distributes the runoff flowing into the gully over a wider area and

reduces the energy given off as water falls a vertical distance. Once the headcut is shaped, the surface soil needs to be protected with one of the methods described below. Planting specifications for seeding and mulch, sprigs and container plants are in Chapter 5.

Type of Headcut Repair	Gully Activity*	Watershed drainage area	Common Reasons for Failure
Shaping and revegetation, herbaceous cover with fabric	low to moderate	1-5 acres	Poor germination rate due to late or early seeding or incorrect seed mixture; mulch or fabric does not stay in place; slope too steep
Shaping and revegetation, other trees and shrubs	low	1-5 acres	High flows tear out plants; insufficient water in dry season; slope too steep; animal damage. Best used after headcut is stabilized with other methods.
Shaping and revegetation, willow sprigs	low to high	1-5 acres	Sprigs planted upside down, too sparsely, not deep enough or too late; sprigs too small; site too shady; insufficient water in dry season; slope too steep; animal damage
Wattles	low to moderate	1-5 acres	Site too shady; insufficient water in dry season; animal damage
Shaping with brush mattress or brush layers; willow wall on shaped or vertical surface	moderate to high	1-10 acres	Anchoring not secure; site too shady; insufficient water in dry season; animal damage
Shaping and rock	moderate to high	Any size	Rock too small; no filter under rock; rock not tightly placed; slope too steep.
Shaping, rock and woody plants	high	Any size	Insufficient water in dry season; slope too steep; animal damage; rock too small; no filter under rock; rock not tightly placed

* Low–Headcut is shallow (less than 2 feet deep) and does not grow noticeably during heavy rainfall. Banks are gently sloped and mostly covered with grass, tree roots or other vegetation.

Moderate–Headcut is shallow, but expands noticeably during winter storms. Banks are gently sloped and mostly covered with vegetation with occasional steep areas of raw, exposed soil.

High–Headcut is more than 2 feet deep and moves rapidly uphill during heavy rainfall. Banks are steep with little vegetation.



Try yourself



Can be used by the layperson under the circumstances described



Requires professional design and installation



Shaping and Revegetation with Herbaceous Cover

In shallow gullies with low flow velocities and good sun exposure, perennial grass forms a strong, dense mat that withstands high flows. Seed mixtures that contain several kinds of grasses are recommended because they provide long-term protection and a backup in case one kind of seed doesn't perform well at the site. Using native grass species supports native wildlife and creates a small reserve for these plants to spread into neighboring areas. Protect the seed with mulch and a natural fiber blanket as described in Chapter 5. You can also try sedge and rush plugs planted 12 inches apart.



Shaping and Revegetation with Other Trees and Shrubs

Rooted native trees and shrubs can also be planted in headcuts and other gully points, but they are not recommended for active gullies until the headcut has been stabilized with other techniques. Since trees and shrubs are best planted during the rainy season, they won't have a chance to grow strong root systems before stormflows, and unlike willows, you can't bury 75% of their length and expect them to live. Coyote brush (*Baccharis pilularis*) is excellent for droughty sites, and sedges (*Carex spp.*) and dogwood (*Cornus sericea*) for shady sites. Use coconut mats to protect exposed soil.



Shaping and Revegetation with Sprigs

Willow sprigs are an effective and inexpensive way to armor active headcuts and gully banks in small gullies, but they require soils that stay moist through the dry season. In fact, by absorbing and using water, they can help dry out an oozing headcut. Remember that willows need a sunny site to thrive. Dogwood cuttings can be used in shady sites.



Willow Wattles, Brush Mattress, Brush Layering, or Willow Wall With or Without Shaping

These techniques, described in Chapter 3 for streambank stabilization, are excellent candidates for headcut repair. Willow wattles or fascines are best in small gullies that drain less than 5 acres; brush mattresses and brush layering can be used in larger gullies that drain under 10 acres. As when using these techniques for streambank repair, we recommend that you consult with NRCS, your RCD, County staff or a professional designer to help select the best method and adapt it to your site.



Shaping and Rock

Rock is commonly used to armor headcuts and nickpoints of large and highly active gullies. Unlike purely vegetative repairs, it remains in the landscape and fixes the gully in place, even when you would rather have it disappear. However, there are times when rock is needed to halt severe erosion. Seek professional assistance before using rock to repair a headcut and make sure to check if you need permits (Chapter 12).

Rock must be carefully sized and installed to stay in place during stormflows. The two most common causes of failure are piping and rock movement. Piping occurs when water finds a cranny between the soil and the rock layer and proceeds to wash away the soil underlying the riprap. A layer of gravel or filter fabric below the rock allows water to percolate through without moving the soil.

Filter fabric is easy to transport and install, but it can inhibit vegetation from becoming established between the rocks. Generally, filter fabric is recommended for slopes steeper than 2:1 (2 feet horizontal run for a 1 foot vertical rise) and gravel for gentler slopes.

Big storms can wash away the most carefully installed rock, but you can substantially reduce the chances of failure by following these guidelines:

1. Slope the headcut back at a gentle angle. A 3:1 is best; 1:1 is minimal and should be used only on slopes less than 2 feet tall.
2. Use angular, not rounded rock.

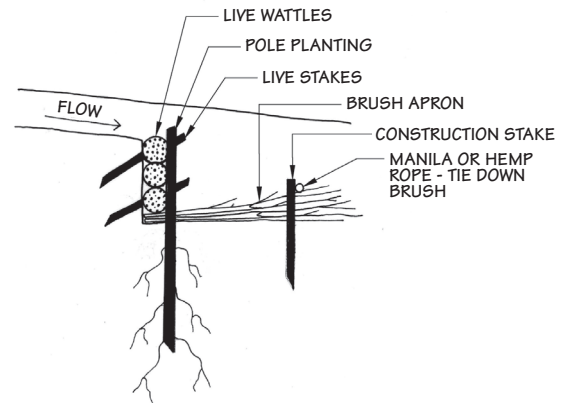

Headcut repair with willow wattles or fascines



Willow wall headcut repair

3. Lock large rocks tightly together with smaller ones. Placing rock is like putting together a jigsaw puzzle—you have to search through the pile to find the right rock for each spot. You should be able to walk on the rock-covered surface without wiggling individual rocks.
4. Use dense rock. Riprap should have a minimum specific gravity of 2.5, which means that a cubic foot of rock weighs 2.5 times a cubic foot of water. Do not use concrete chunks; they have a much lower specific gravity and can be toxic to wildlife.
5. Size the rock according to the flow velocity. It's good also to look at neighboring drainages with similar flow velocities and see what size rock stays in place there. Bigger is always better.
6. Check the rock work frequently during the first two to three winters. If you see any cavities, rearrange the rocks securely, or pack them tightly with stones or flexible, leafy brush.

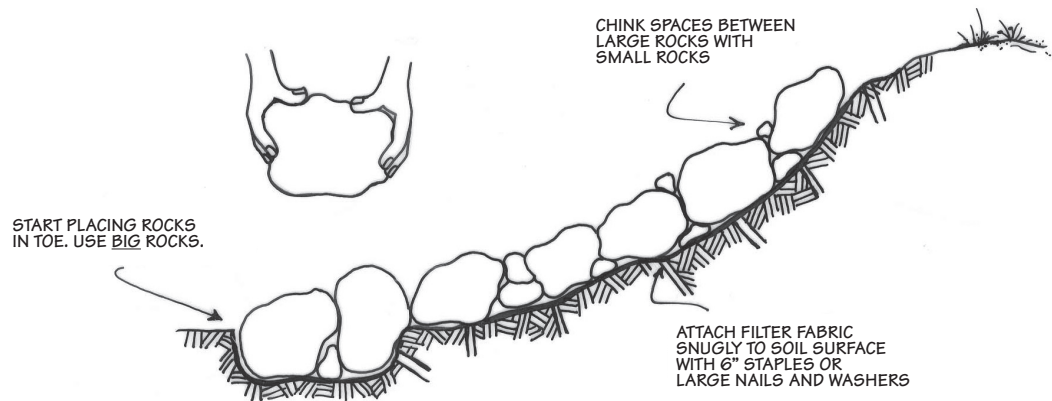

Hand rock placement

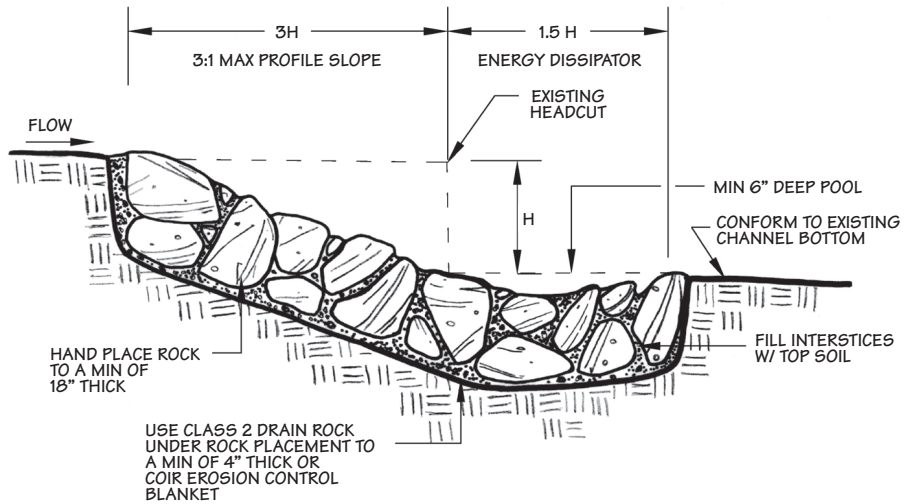

NOTE: "H" = HEIGHT OF EXISTING HEADCUT

Rock headcut repair, profile

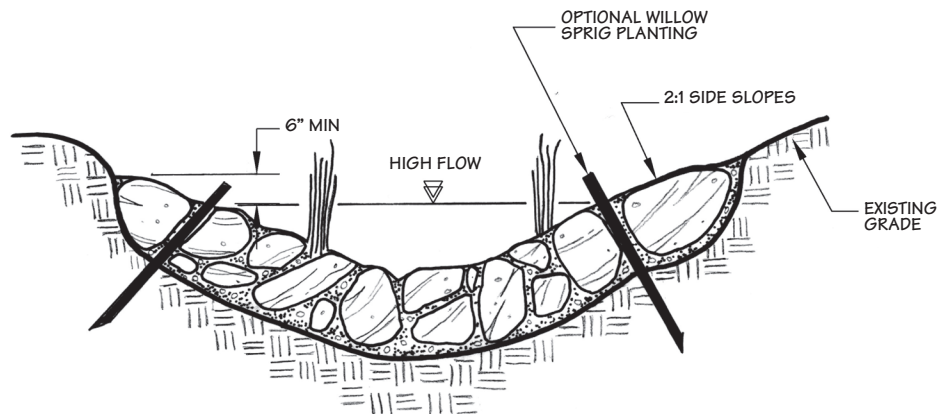

Rock headcut repair, section



Shaping, Rock Riprap and Woody Plants

Willow sprigs or other trees and shrubs planted between rocks add both wildlife value and stability to headcut repairs. The sprigs are best driven into the headcut first and the rock placed around carefully them. However, if the rock work needs to be installed before the willows are dormant, PVC pipe can be inserted while the rock is placed, and then removed and replaced with sprigs. Gravel works best under the rock instead of filter fabric when adding plants, although willow sprigs can be poked through fabric on the sides of the headcut.



to



Diverting Flow

Diverting the water from a gully can be an effective but risky way to reduce headcutting. This method is best used when the gully has clearly been caused by channeled drainage, as in the case of a road culvert focusing the runoff from a wide area into a narrow channel. Because rain and groundwater will collect in the gully even if the major flow has been rerouted, the headcut will still require armoring, although it need not be as sturdy as without the diversion. Diversion alternatives include the following:

- Redistributing the runoff to better match natural runoff patterns. An example is the outsloping of ranch and forest roads (Chapter 6) to allow water to drain evenly off the entire road surface instead of through a few culverts.
- Redirecting the runoff to a different area. Extreme care must be taken with this method because it can recreate the same problem in a new spot. It should be used only when no other options are available and then with some good professional advice. The runoff should be directed to a stable area, either a natural rock outcrop or an energy dissipator as described for road repairs in Chapter 6.

Preventing downcutting: grade stabilization

Once the headcuts are stopped, another option is to slow down the flow and to raise the level of the gully. Checkdams or grade stabilization structures accomplish both of these tasks. Checkdams extend above the gully bottom and trap sediment over time. Grade stabilization structures are backfilled at the time of construction. They allow more control over the gully flow and final shape, but they typically require heavy equipment. We recommend you seek professional assistance for both techniques.

Checkdams fall into two broad categories: porous and impermeable. Porous checkdams allow water to percolate through the dam face. Sediment is deposited more slowly upstream than if the water was completely stopped, but such dams are more resistant to blowouts than impermeable dams and they are able to adjust to small changes in the shape of the gully bottom. Materials used to construct porous checkdams include strawbales, woven willow branches, brush, loose rock and logs. Impermeable checkdams include board, compacted earth, mortared rock and concrete structures. In this handbook, we focus on porous dams because they are safer and generally more effective over time.

As long as the basic guidelines are followed carefully, many other on-site or readily available materials can be used for constructing checkdams. Since the dams are in watercourses, avoid using toxic materials, such as creosoted railroad ties, concrete chunks or pressure-treated peeler poles. Remember also that the dam will last only as long as the materials used to construct it, unless deeply-rooted vegetation is either planted in the deposited soil or allowed to grow back naturally.

Guidelines for Checkdam Construction

1. Leave plenty of room for water. You want your gully channel to be able to carry stormflows safely without causing additional erosion.
2. A series of short checkdams is usually more effective than fewer tall structures. If one dam fails, the entire gully repair will not be threatened. Also, since taller dams work harder, holding back a greater volume of water and soil, small flaws in construction are more likely to cause major failures. Short dams can be raised over a period of years, if necessary, to heal a deep gully. No dam should have an effective height of more than three feet without being designed by an engineer.

3. Use a level to space the checkdams so that the toe of one is level with or slightly below the crest or spillway weir of the downstream dam (see illustration). Otherwise, the gully will continue to deepen and undermine the upper checkdam.
4. Most checkdams require a spillway to contain overflows and prevent cutting of the gully banks. For gullies where there is little or no risk to property or safety, the spillway should be large enough to accommodate a 10-year storm if the drainage area is less than a few acres. Repairs in gullies that do pose significant risks should be designed by a registered design professional. In a small gully, you can experiment with the size of the spillway. Start bigger than you think, and be prepared to enlarge it during the winter. Your NRCS field office can help you determine spillway size. Be careful to aim the spillway at the bottom of the gully, not the sides, even if this requires that the spillway be off-center.
5. Always provide a nonerodible energy **dissipator** (or apron) at the downstream end of the structure for the checkdam overflow. Rock and securely anchored brush are two of the most commonly used materials. During high flows, the aprons are subject to tremendous force. Aprons that are too short or not strong enough are frequent causes of checkdam failure. A piece of filter fabric or a layer of gravel should be placed under the rock to prevent the soil from washing away. The apron should extend across the entire width of the gully.

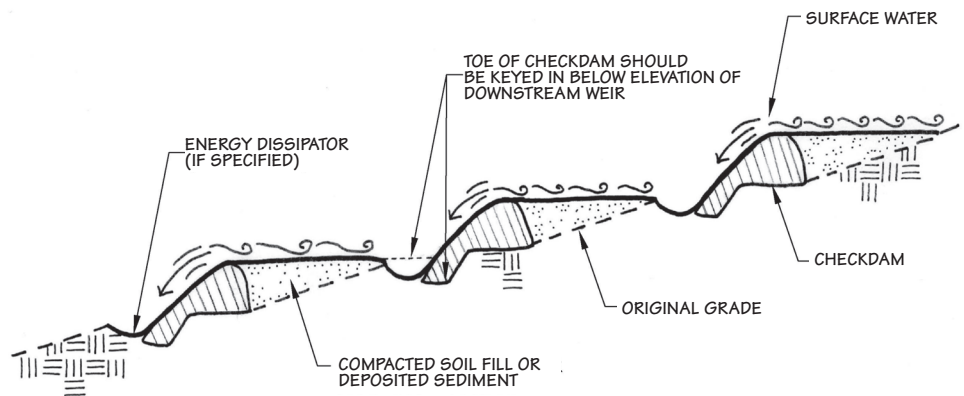

Checkdam placement

6. The top of the checkdam must be level. Even with a large spillway, stormflows sometimes overtop the dam. If the water is focused on one bank, your dam will probably fail.
7. Key all checkdams securely into the gully banks and bottom. Key depth varies according to the size and type of dam and is discussed further in the following descriptions of checkdams. The soil around the keys should be firmly tamped in 6-inch lifts. Only soil, no rocks, should be used. If the soil is very dry or very wet, it won't compact well.
8. Construct checkdams perpendicular to the flow. This is easy in a straight gully, but a little tricky in a more typical, sinuous one.
9. Make sure you have all the necessary permits. Many gully repairs, particularly those that use rock, are subject to the same permits as streambank repairs. Any work where threatened or endangered species occur also requires permits.

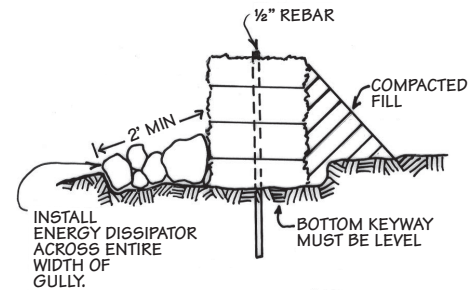

Strawbale checkdam



Strawbales

Strawbales are an inexpensive and easy-to-install form of checkdam for use in mild, shallow gullies. They perform best in gullies with relatively stable sides and some existing grass cover. Since the bales deteriorate in two to three years, it is essential that vegetation be well established on the deposited sediment within that time. Bales should be keyed into the bank as shown and secured with two pieces of rebar or stakes per bale. Multiple bales can be used in a row across the gully floor. Use rebar with caution. Once the bales disintegrate, the standing rebar can hurt livestock or people. Generally, single strawbale checkdams are constructed without spillways. Multiple strawbale dams can be arranged so that the center is lower than the sides.



Brush Checkdams

Brush checkdams are especially useful for hard-to-reach, small gullies with a plentiful source of woody branches nearby. Brush checkdams

are usually anchored with wooden poles, preferably willow, but $\frac{3}{4}$ -inch rebar or steel t-posts (triangular fence posts) can also be used. A 6-inch layer of organic litter is laid on the gully floor both upstream and downstream of the posts, and then green branches are stacked on top of the litter, butt end upstream, packed down securely and then tied to the posts with strong rope. Longer branches should be placed on the bottom, extending further downstream, to form the energy dissipator. Leaf litter or erosion blanket is placed at the upstream end of the checkdam to catch fine sediment. References #14 and #15 have more information on constructing brush checkdams.

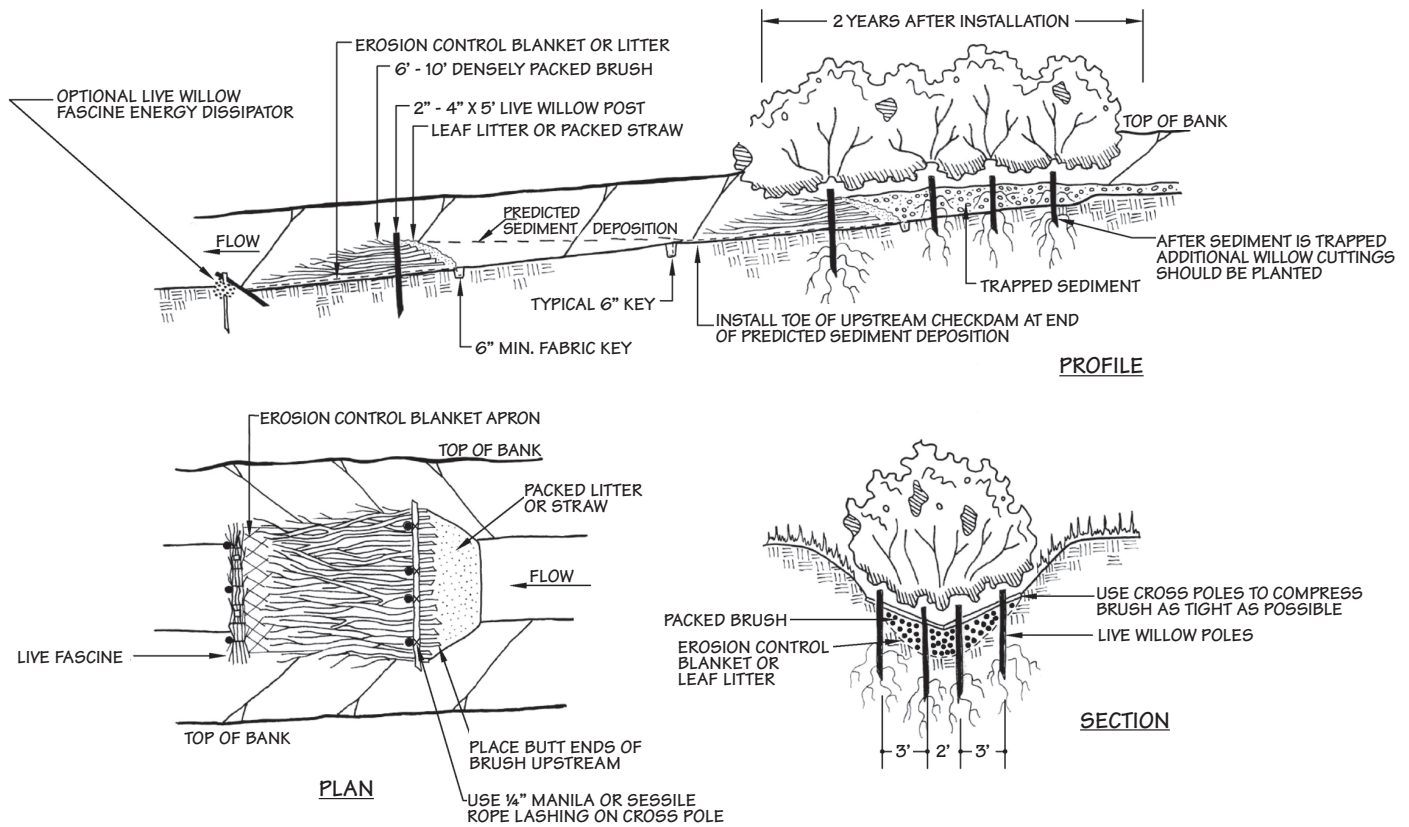

Brush checkdam



Log Checkdams

Checkdams made from on-site logs are suitable for small gullies with a width of 3 feet or less. Unless backed with filter fabric, log dams should be used only where the runoff is rich in organic litter. Most available wood can be used, but remember that some species, such as California bay and alder, rot too quickly for plants to become established. The closer the logs fit together, the more effective the dam will be in trapping sediment. The logs should be inserted at least 1 foot deep into the banks and 6 inches into the gully bottom. A spillway should be cut into the top log, but always leave at least 4 inches of the log diameter intact or the log may break under force. The apron can be either rock over a layer of litter or filter fabric, or a thick layer of securely anchored leafy brush. If filter fabric is not used, the upstream toe of the dam should be sealed with a 6-inch layer of organic litter held in place with small rocks, or with small gravel (3/4 inch or smaller) mixed with pebbles and coarse sand. The upstream rocks need not be as large as those forming the apron, since the dam itself will prevent them from rolling downstream.



Rock grade control structures

These are constructed in large, actively eroding gullies either at grade (the same level as the existing gully bottom) to prevent downcutting, or above grade and backfilled to restore a more stable gully slope. They require professional design and installation. If all of the structures needed cannot be built at one time, find a stable base point such as a flat slope, a bedrock outcrop or a culvert, and begin installing them upstream of this point so they won't be undercut as nickpoints move upstream.

USING PLANTS TO PREVENT AND REPAIR EROSION



COMMON MARIN INVASIVE PLANTS

Giant reed *Arundo donax*
Periwinkle *Vinca major*
Scotch broom *Cytisus scoparius*
French broom *Genista monspessulana*
Spanish broom *Spartium junceum*
Himalayan blackberry *Rubus discolor*
Tree-of-heaven *Ailanthus altissima*
Bamboo
Pampas grass *Cortaderia selloana*
German or cape ivy *Delairea odorata*
English ivy *Hedera helix*
Acacia spp.
Ice plant *Carpobrotus edulis*
Medusahead *Taeniatherum caput-medusae*
Oblong spurge *Euphorbia oblongata*
Italian thistle *Carduus pycnocephalus*
Barbed goatgrass *Aegilops triuncialis*
Yellow starthistle *Centaurea solstitialis*
Purple starthistle *Centaurea calcitrapa*
Distaff thistle *Carthamus lanatus*
Gorse *Ulex europaeus*
Harding grass *Phalaris aquatica*
Veldt grass *Ehrharta spp.*
Velvet grass *Holcus lanatus*

Living plants provide the best erosion control in most situations. Even when a hardened surface is needed, plants can usually be incorporated into the repair, as we describe in the chapters on streambank and gully stabilization. Restoring native plants to a disturbed area provides the raw materials for healing to continue when new erosion develops. Alder seeds, for example, wash downstream to settle and germinate on newly deposited sediment.

Anyone who has ever tried to dig up a patch of native grass knows just how deep and dense the roots grow. It's hard to even pierce the soil surface with your shovel, no matter how hard you stomp on it. While roots hold soil in place and absorb water, the plant's leaves intercept raindrops before they hit the ground, thereby reducing their erosive force.

Native plants have evolved to fit specific soil and climate conditions and to provide food and shelter for native wildlife. When you use native trees, shrubs, grasses and wildflowers for your erosion control, you help restore habitat for birds, salmon and steelhead, pond turtles, butterflies and many other wild animals. When you use exotic species, you crowd out native plants and reduce habitat value. Marin County Stormwater Pollution Prevention Program (MCSTOPPP) has more information on native plants on their website, as well as two guides, *Creek Care* and *Go Native* with plant lists, instructions, and local nurseries (References #26 and #27).

Never use invasive exotic plants for erosion control. These plants, such as the giant reed (*Arundo donax*) or cape ivy (*Delairea odorata*), aggressively out-compete native plants to dominate entire areas.

Here are a few basic tips for plant selection for stream and gully restoration:

1. Use native plants that belong in your area.

2. Find a reference reach in the same watershed or in a neighboring one. Reference reaches, defined more thoroughly in Chapter 3, are well functioning areas where you can see which plants thrive and where they grow best.
3. Choose a variety of plants. If one is weak or slow to get started, the others can fill in. Plant diversity also increases the types of shelter and food for wildlife.
4. Be careful where you plant willow sprigs, especially shrubby arroyo willows (*Salix lasiolepis*). Although they provide outstanding habitat and erosion control, they can spread across channels in slow moving streams. Do not plant them in channel bottoms or near bridge or culvert openings. In situations where exuberant growth could cause problems, consider planting other willow species that grow in less aggressive, tree forms.
5. Promote structural diversity to encourage bird diversity. A mixture of herbaceous plants, shrubs and trees provide the best protection from predators and the greatest choice of nesting sites.
6. Plant the same species in clusters of 3 plants or more.
7. For stream plantings, plant extra trees on the south bank to promote shade.
8. If trees don't work for your site or management needs, don't give up on planting. Grasses, sedges, and shrubs all provide excellent erosion control and important wildlife habitat.

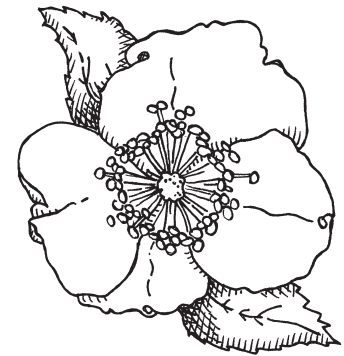

Seeding

Seeding grass and other herbaceous plants, such as clovers and wildflowers, is best done in September and early October. California native perennial grasses are now commercially available. Different species do better in sun or shade, heavy soils or sandy soils, droughty sites or wet sites. A common erosion control mixture for Marin and Sonoma Counties includes blue wildrye (*Elymus glaucus*), meadow barley (*Hordeum brachyantherum*) and California brome (*Bromus californica*). Your seed vendor or the other native plant nurseries can help you select a seed mix that fits your site depending on soil type, soil moisture regime, and amount of shade. Although native perennial seed costs more than many of the typical introduced annual seed mixes, the long-term

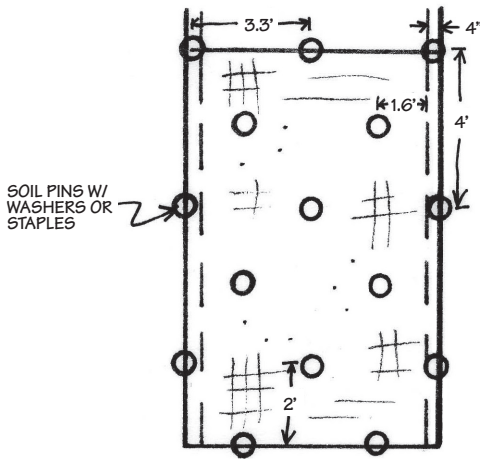

Pin spacing for erosion control blanket
on a 2:1 slope

benefits in longevity and deep root structure may well overtake any short term savings.

Before seeding, areas of bare soil should be smoothed and raked on contour to minimize uneven surfaces and reduce any potential concentration of water which may cause rilling. If the soil is compacted, deeper ripping or disking may be required. Broadcast seed at a rate of 40-60 pounds per acre or 1-1½ pounds per 1000 square feet. Many seed dealers rent hand spreaders (sometimes called "belly-grinders") that can be set at the required rates. Otherwise, hand broadcast the seed as uniformly as possible. Immediately following seed application, lightly rake the seed on contour or roll it with a lawn roller but do not bury seed more than one-quarter inch deep. It's fine for some seed to be showing.

The surface should then be covered with a mulch, both to hold the seed on the slope and to protect it from hungry birds and small mammals. Where slopes are gentler than 2:1 (2 feet of horizontal distance for 1

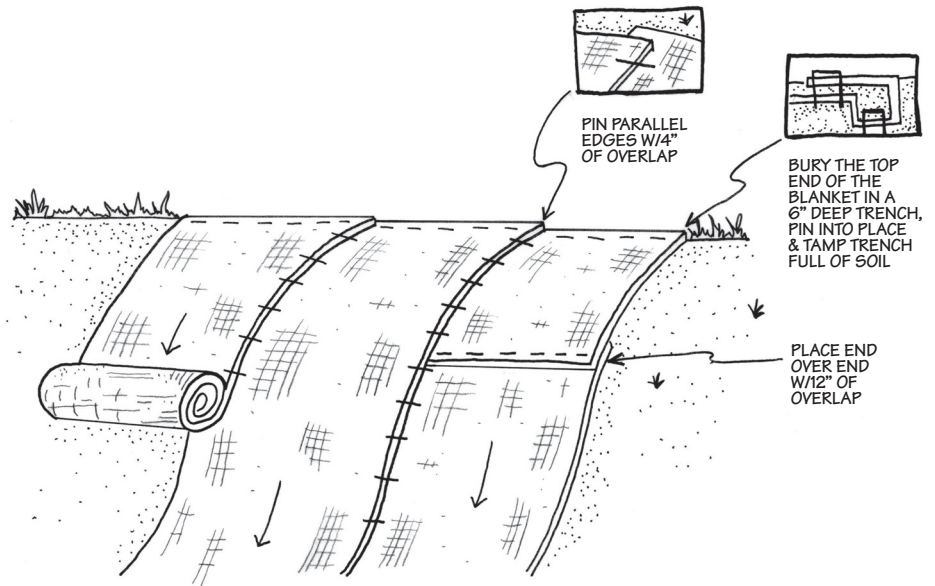

Erosion control fabric installation

foot of vertical distance), spread a layer of weed-free rice straw approximately one inch thick, or 3,000 pounds per acre. Some soil should be showing through the straw. When finished spreading the straw, water it so that it doesn't blow away. You may need to water it again or apply a tackifier if the straw dries out too much before the rainy season. A scheduled regular watering can speed up the germination process so that your seeding has a head start before the heavy rains come.

In areas of steeper slopes, or swales that will be carrying flow, cover

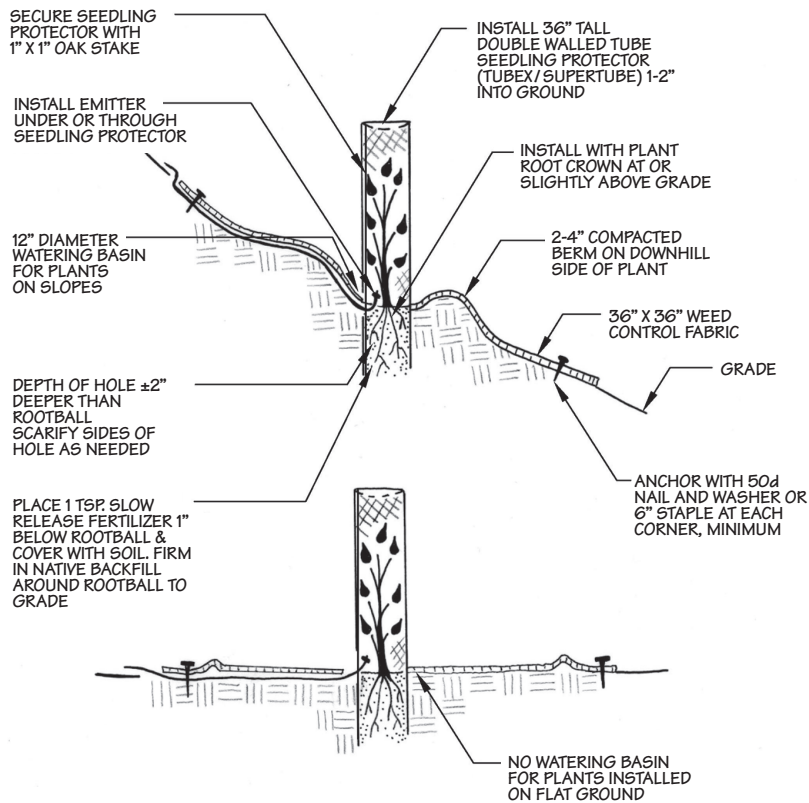

NOTE: REMOVE SEEDLING PROTECTOR AFTER 3 YEARS OR WHEN PLANT IS WELL ESTABLISHED

Planting details for slopes and flat ground

the seed with a straw or coconut erosion control blanket following the manufacturer's instruction. Do not use blankets with plastic netting which can trap birds, snakes and other small wild animals. The blanket must be secured evenly across a smooth soil surface to avoid tenting.

Planting woody plants

Rooted trees and shrubs are best planted in the winter when they are dormant. Small plants are inexpensive and with care, may quickly catch up in growth with 15-gallon or larger plants. Make sure your plant's roots are not jammed into its pot. Trees that have been grown in long Treepots or Deepots often transplant more successfully than those grown in shorter containers in which the roots may spiral and eventually girdle the plant.

Weed mats or mulch will keep weeds from choking out new plants, and plant protectors keep browsers at bay. When planting trees, consider how your site will look when the trees are 20 feet tall and 10 feet wide. You don't want to plant them so close together that you need to thin them out. And you definitely don't want to plant a tall-growing tree under a power line.

Some plants, such as oaks and buckeyes, can be grown directly from seed. See Chapter 13 for information resources on growing plants from seed.

Willows are among the first plants to break dormancy, and should be collected and planted from October through December. Willows respond well to heavy pruning, so don't be too worried about collecting generously from a grove. Thin, however, instead of clearcut in order to leave cover for the resident fauna. Cut branches back to the main stem or a bud which will re-sprout.

For sprigging, use straight willow branches that are between 3/4 to 1 1/2-inch in diameter and about 3 feet long. Be sure to plant the willows right-side up. One almost foolproof method is to cut an angle on the planting end of the sprig right after it is pruned from the tree. Use a heavy digging bar to prepare a hole, and then step around the sprig to firm the soil. The sprigs should be inserted into the soil 75 to 80% of their total length. If you can't get it in as deeply as you like, trim the sprig with loppers to achieve the right ratio. Remember to choose the right type of willow for your site. (See Planting Tip 4.)

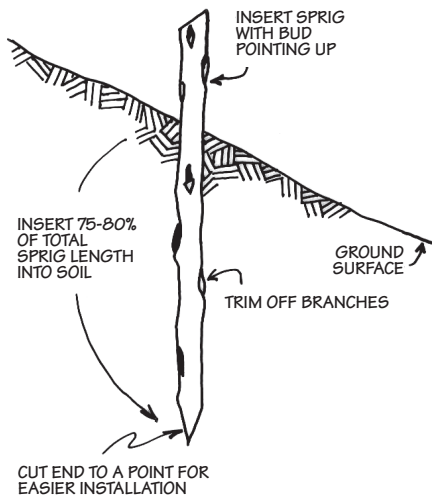

Willow sprig

A PARTIAL LIST OF WOODY PLANTS IN MARIN COUNTY

		Tolerates partial shade	Tolerates clay soil	Tolerates wet conditions	Tolerates dry conditions	Evergreen
Trees						
<i>Acer macrophyllum</i>	big leaf maple				☞	
<i>Acer negundo</i>	boxelder			☞		
<i>Aesculus californica</i>	Calif. buckeye		☞	☞	☞	
<i>Alnus rhombifolia</i>	white alder	☞		☞		
<i>Cornus sericea</i>	American dogwood	☞	☞	☞		
<i>Crataegus douglasii</i>	hawthorn		☞	☞		
<i>Fraxinus latifolia</i>	Oregon ash	☞	☞	☞		
<i>Juglans californica</i> var. <i>hindsii</i>	Calif. black walnut		☞	☞		
<i>Myrica californica</i>	waxmyrtle			☞		☞
<i>Quercus agrifolia</i>	coast live oak				☞	☞
<i>Quercus kelloggii</i>	black oak				☞	
<i>Quercus lobata</i>	valley oak		☞	☞		
<i>Salix</i> spp.	willows		☞	☞		
<i>Sequoia sempervirens</i>	coast redwood	☞		☞		☞
<i>Umbellularia californica</i>	Calif. bay-laurel	☞	☞	☞	☞	☞
Shrubs						
<i>Baccharis pilularis</i>	coyote brush		☞	☞	☞	☞
<i>Calycanthus occidentalis</i>	spice bush	☞	☞	☞		
<i>Corylus cornuta</i>	hazelnut	☞			☞	
<i>Heteromeles arbutifolia</i>	toyon - christmas berry	☞			☞	☞
<i>Lonicera hispidula</i>	Calif. honeysuckle	☞				
<i>Rhamnus californica</i>	coffeeberry	☞			☞	☞
<i>Ribes sanguineum</i>	pink flowering currant	☞				
<i>Rosa californica</i>	Calif. rose		☞	☞		
<i>Rubus ursinus</i>	Calif. blackberry	☞	☞	☞		☞
<i>Sambucus mexicana</i>	blue elderberry					
<i>Symphoricarpos mollis</i>	creeping snowberry	☞				
<i>Vaccinium ovatum</i>	huckleberry	☞			☞	☞
<i>Vitis californica</i>	Calif. grape	☞	☞	☞	☞	

NOTE: These species are available from native plant nurseries and have been used successfully in restoration projects.

Wet conditions = low bank, floodplain

Dry conditions = upland slopes

The spacing of the sprigs depends upon the activity of the erosion. In more stable areas with relatively small watersheds, the sprigs can be placed 2 feet apart. In large or rapidly eroding gullies, space the sprigs 1 foot to 18 inches apart.

Cattle and deer find tender, young willow sprouts quite delectable. Be forewarned, and protect your plantings if you expect them to be exposed to heavy browsing.

Caring for your planting

Woody container plants need maintenance for several years. All require weeding and eventual removal of the plant protector. Although some plants can live without watering, survival rates are much higher for many container-grown species with two to three years of summer water. Unless you are caring for only a few plants within reach of your garden hose, you will probably want to install drip irrigation or a slow-release gel pack (such as DriWater® or Rain Bird® Irrigation Supplement). The gel slowly releases water into the root zone. The packs must be replenished two to four times per season depending on conditions and the manufacturer's recommendations. When using drip or hand watering, allow the soil surface to dry out between waterings to prevent root rot. Depending on soil texture and solar exposure, watering once or twice per week should be adequate.

Where trunk girdling by mice is a problem, consider a commercially available spiral tree wrap. If deer browsing is severe, consider building tall wire cages around individual trees or erecting temporary deer-net fencing. Be careful not to block wildlife migration corridors or allow flood waters to carry away the plant protectors.



Susan Pinkerton



ROADWAYS

Unsurfaced roads, driveways and even horse trails and footpaths contribute sediment directly, as well as cause and accelerate other erosion problems. When building a new roadway, most of the typical problems can be avoided. However, in many areas of northern coastal California, the unsurfaced roads were built many years ago, often to access logging or remote ranchland, and have been plaguing watersheds ever since. References #11, #30 and #32 are excellent handbooks for designing, constructing and maintaining safe and nondestructive small roads. We recommend that you seek experienced professional help for repairing significant road drainage problems, all culvert and bridge installation, and designing and building new roads. Work on trails and driveways where there is no risk of damaging structures, other roads, utilities, or streams, where you can accomplish your work with a shovel and your hands, and where you can check it regularly during winter, can usually be done safely by landowners. If in doubt, contact your local NRCS or RCD office.

The following process can help get an eroding unsurfaced road, driveway or trail in shape, as well as provide guidance for avoiding the same mistakes when constructing new roadways.

Evaluate, and if necessary, modify the surface drainage.

Most road erosion and related problems, such as gullies and landslides, are due to the way runoff reacts to the road surface. Through grading, the road drainage can be modified to reduce or eliminate such problems. The objective is to have the runoff travel as short a distance as possible before safely crossing the road and leaving at a well protected, non-erodible point. The longer the water travels along the road surface, the more likely it is to concentrate into rills and washouts.



Types of surface road erosion

One road can incorporate several kinds of drainage to achieve this objective. There are four basic types:

- **Inboard ditch.** The road is graded into the slope. Water from the road and the hillside above it collects in a ditch and either runs the entire length of the hill or exits through culverts or water-bars. When properly constructed and rigorously maintained, the advantage of this method is that runoff is carefully controlled and can be channeled to well-protected areas. However, often poor construction and infrequent maintenance lead to plugged culverts, washouts and gullies.
- **Crown.** The road surface is sloped gently towards both sides. This is usually used only on high-quality roads, often in conjunction with large cut and fill slopes. It is relatively uncommon on lightly used roads. Ditches and culverts carry runoff to either side, depending on slope.
- **Outslope.** The road is graded with the slope at a gentle angle. Culverts and ditches are not necessary, except where streams cross the road, because runoff sheets evenly from the road surface. Outsloping is the least destructive method to the natural drainage patterns. However, it may present a safety hazard on roads in clay soils, especially on curves.
- **Middle of the road.** Some old roads were constructed straight down the middle of a creek or as a trough cutting through a hill. The only safe way to get water off them is to direct it into lined ditches on one or both sides of the road. In some cases, the only way to prevent serious erosion on such roads is to abandon, recontour and revegetate them, and build a better road elsewhere.

Herbaceous vegetation also helps protect road surfaces and slow runoff. On seldom-used roads, a grass-seed mixture can be sown directly on the roadbed to protect it during the winter season. Existing low plants should not be graded from roads unless they pose a fire hazard or dangerously limit visibility.

Transport water safely across the roadway.

Whenever there are ditches, or where streams and winter swales cross an unsurfaced road, look for erosion problems. Even a slight washout or rilled area that has to be regraded every year can contribute tens of tons of sediment to the nearest stream over a few years. One way to get

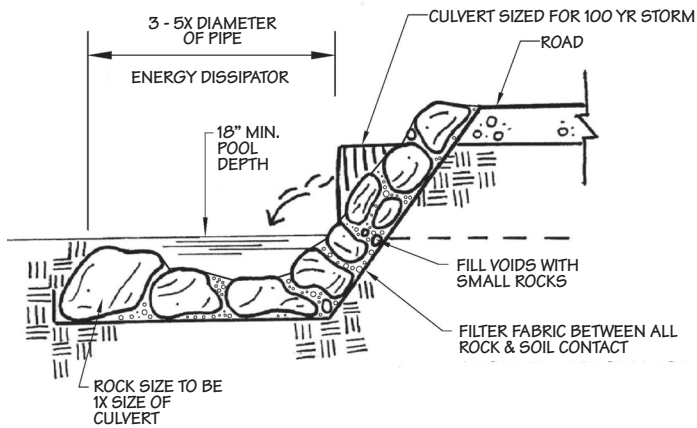

NOTE:
FOR PIPES UNDER 3' DIAMETER

Rock energy dissipator under culvert

a handle on how much soil has washed away from a seemingly stable road surface is to lay a flat stick or board across the road. Assuming that the road was once graded to a relatively flat surface, the ground between the stick and the current surface has been lost.

All types of cross-drainage except outsloping require that the water leave the road into well-vegetated, low-gradient ground or a protected outlet. Rock energy dissipators are the most common form of protection. The rock should be placed over gravel or a filter fabric blanket with voids between the larger rocks filled with smaller ones. As with all rock used for erosion control, it should be angular and large enough to withstand heavy flows. Rock energy dissipators should be built into a bowl or trough-shaped depression dug into the ground with the downstream end rocks at the same elevation as the natural ground. Make sure that the water does not discharge into fill or easily erodible native soil once it leaves the dissipator.

The method employed to transport flow across the road depends on how much use the road receives, the volume of flow, whether the road is regularly maintained and, of course, your budget. The last item can be deceptive, since more costly methods, such as bridges, often quickly make up for the high price of installation in reduced long-term maintenance costs. All methods must be sized to handle the desired stormflows. Here are four possible choices:

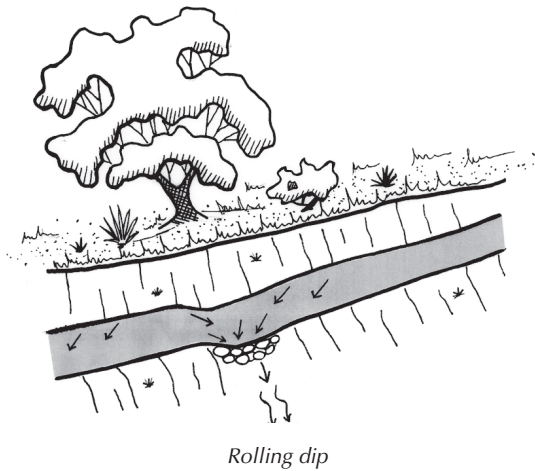

Rolling Dips

Rolling dips are smooth depressions in the road surface used in outslopped roads. The uproad side of the dip is outslopped and has a gradual, gentle cut below the original road surface. The downroad side comes back up to the road grade at a slightly steeper slope to keep the water from breaking out of the dip. Rolling dips are permanent features and should be constructed so that they are easy to drive over. They need to be placed at sufficient intervals to prevent the road surface from rilling, but far enough apart for uninterrupted vehicle travel. Make sure that they exit at a stable, protected area. Rolling dips should not be constructed in unstable fill slopes or for road gradients over 12%.



Waterbars

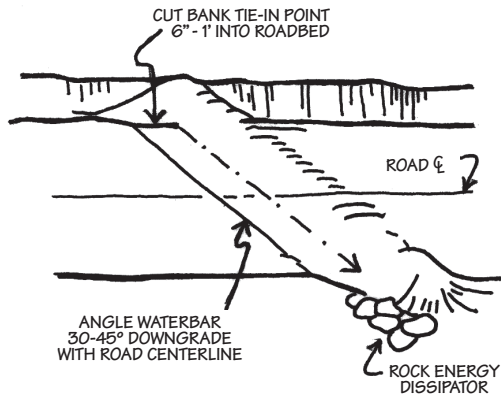

Waterbars are a temporary means of breaking surface flow over sloped sections of seasonal road. In a pinch, they can be constructed with hand tools. They consist of a shallow ditch and rounded berm placed diagonally across the road surface. Often they must be reconstructed every year because they either wear down during the summer or are so annoying to those who regularly use the road that they are graded out. As with rolling dips, make sure the waterbars direct flow to a protected area that will not erode.

Waterbars can be made more palatable by increasing the width and thereby reducing the slope of both the ditch and the berm. Installing a series will reduce the flow volume and hence the cutting action in each waterbar.

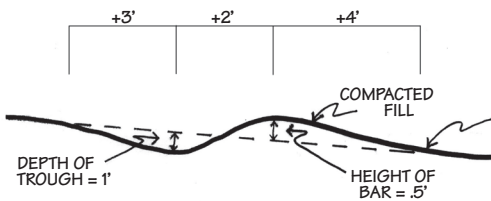

Water bar

WATERBARS

Estimated Hazard Rating	Road or Trail Gradient			
	10% or less	11-25%	26-50%	50% or more
extreme	100	75	50	50
high	150	100	75	50
moderate	200	150	100	75
low	300	200	150	100

Maximum distance between waterbars in feet. (California Forest Practice Rules, 1999)



Fords

Fords can be used to carry ephemeral or intermittent streams across roads with very light traffic, such as ranch roads. They are essentially rolling dips surfaced with rock or concrete and should be designed for specific sites with help from NRCS or a registered professional designer. Ford construction requires permits from those agencies regulating work in watercourses (Chapter 12).



Culverts

Installing a culvert is one of the riskiest management actions one can take. Culverts confine and concentrate flow. They interrupt sediment transport and frequently block fish. They are a major source of sedimentation in many watersheds through road failures and gully erosion. However, if they are properly sized and installed in the right place, they can be very handy. Specifications for spacing and installing culverts are given in Reference #32, but we will emphasize several critical guidelines here. Culvert installation in streams of any size requires permits from those agencies regulating work in watercourses (Chapter 12). Ditch relief culverts used to carry winter runoff solely collected from the road surface during rains may not require permits.

Culverts carrying ephemeral or intermittent stream flow should follow the natural stream alignment. They should be set below the original stream grade to allow for a natural streambed to form inside the culvert. Those that carry flow from inboard ditches should exit where they will not cause subsequent erosion. Place large rock carefully underneath the outflow as described above to protect the underlying soil. If the runoff has to travel over fill slopes or unstable areas after it leaves the energy dissipator, make sure to carry it through a downspout or rock-lined channel. Never let a culvert extend in the air and shoot the discharged water onto the soil below. This invariably causes severe erosion and road failure.

Culverts carrying perennial streamflow or wherever fish are present should be designed by a certified professional designer. Fish, as well



Concrete Ford

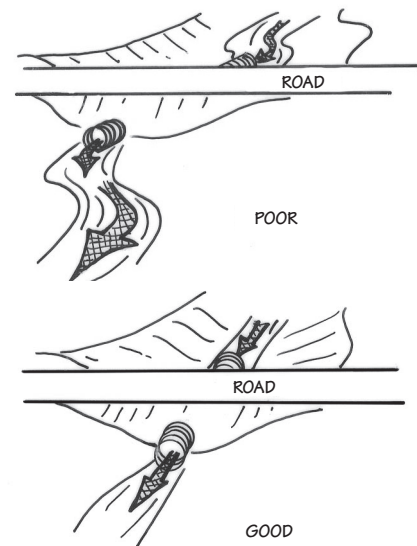

Culvert alignment under road



Arch culvert with natural stream bottom



Traditional box culvert with concrete bottom

as the stream's sediment load and flows from 100-year storms, must be able to pass through the culvert. Arch, open bottom or box culverts are often used so that the natural stream bottom can remain intact.

Plugged culvert inlets are one of the most common causes of road washouts. They should be cleaned before the rainy season and checked during storms. If a culvert plugs after every major storm, consider using another method and/or addressing the upstream source of debris. Trash racks or perforated risers can also help keep the culvert open, but they are certainly not maintenance-free. Culverts should be sloped downward to prevent sediment from accumulating inside.



Bridges

Where they are feasible, bridges are the ultimate drainage solution because they leave fish passage and stream function intact. Many pre-built bridges are now available for small roads and trails. Railroad flatcars have been used successfully in numerous Marin and Sonoma County sites for ranch road crossings. They do require engineered abutments and County permits.

Undertake a regular maintenance program.

Many road erosion problems can be nipped in the bud if the road is well maintained. A good dry-season maintenance program should include replacing energy dissipators that have washed away, cleaning culverts, replacing inadequate culverts with larger ones or another type of cross-drainage, adding additional cross-drainage if necessary, smoothing rills to prevent them from growing into gullies, modifying the surface drainage as needed and, in early fall, seeding the roadbed or adjoining areas of exposed soil. When grading the road surface, spread the scraped soil evenly over the road edge instead of forming berms which collect and channel flow. In winter, energy dissipators should be inspected and reinforced if necessary, culverts and ditches kept clean, and rill erosion checked by constructing waterbars. Winter is also the best time to note where changes in surface or cross-drainage are needed. As the major causes of road erosion are repaired, maintenance will become easier and our streams cleaner.



NEW CONSTRUCTION

Building anything, whether a standing structure, a road, a parking lot or a playground, almost always involves removing vegetation and changing drainage patterns—actions which can provoke and accelerate soil loss. This chapter is divided into two main sections—one on designing your project to reduce storm runoff and increase infiltration, and the other on preventing erosion and sedimentation during construction.

Design for Better Infiltration

Through incorporating materials and practices that reduce storm runoff into new construction, you can prevent erosion and help maintain the natural function of your watershed. Check Chapter 13 for resources for design ideas, specifications and local examples. The following are

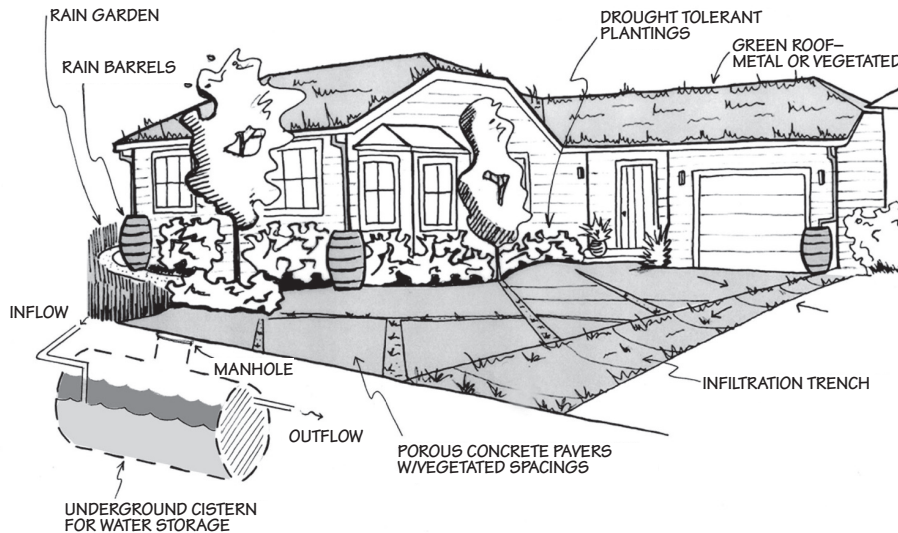

Infiltration techniques at home

basic elements to consider to increase the amount of rainfall captured and retained on your site:

1. Reduce impervious surfaces.

Hard surfaces including roofs, streets, parking lots and paved drive-ways do not allow any water to soak into the soil. Consider using gravel, strips of concrete with grass or gravel in the middle, pervious concrete, concrete unit pavers or other permeable pavements for drive-ways and paths. Incorporate vegetated islands and grass-lined swales into parking areas. The adventurous may want to investigate green roofs that are built to accommodate living grass and other plants on either part or all of the roof surface.

2. Capture and dissipate runoff.

When hard surfaces are necessary, direct the resulting runoff into an area or structure where it can slow down and soak into the ground. Foundation plantings, for example, can break the force of rain falling off

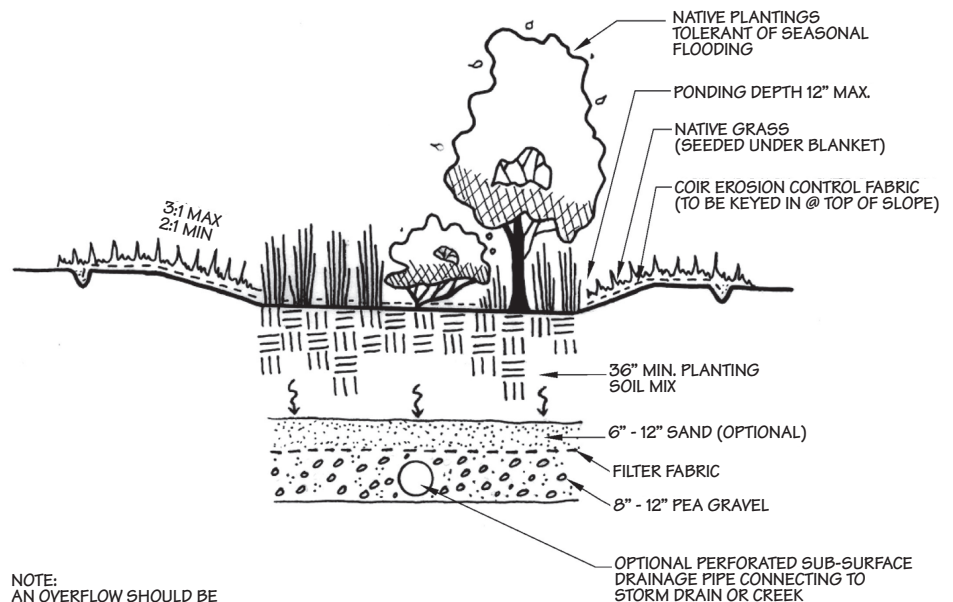

Bioretention basin

a roof. Roofs can also be used to collect water which can be directed into dry wells to recharge groundwater or stored in rain barrels or cisterns for irrigation or other uses. **Bio-filtration swales**, shallow ditches planted with dense grass, can transport water slowly from a downspout or driveway outlet while simultaneously allowing much of it to percolate into the soil. **Rain gardens** and **bioretention basins** pond water and use soil, organic mulch and both woody and herbaceous plants to trap sediment, increase infiltration and remove pollutants.

3. Disconnect surface runoff.

Leave or install permeable areas between roofs, driveways, parking lots and streets to slow and disperse flow instead of creating a speedway for storm runoff.

4. Keep existing plants...and plant more.

Vegetation is the best defense against erosion. Protect trees and shrubs during construction, and consider planting more. Remember that native plants support birds and other wildlife as well as protect soil.

Erosion Control at Construction Sites

Stormwater pollution from development sites is regulated through the State Water Resources Control Board's General Permit for Discharges of Storm Water Runoff Associated with Construction. Construction-related pollution sources include oil and grease, asphalt, concrete, paint and solvents, sanitary waste and pathogens from temporary restrooms, and of course, sediment from disturbed and stockpiled soil. Most cities and counties have enacted local ordinances to comply with the General Permit. The Marin County Stormwater Pollution Prevention Program (MCSTOPPP) and the Sonoma County Permit and Resource Management Department (PRMD) both have helpful websites to guide builders to the right ordinance (Chapter 13).

In addition, owners of any construction project that disturbs 1 or more acres of soil must submit a Notice of Intent to the State Water Resource Control Board and prepare and implement a **Storm Water Pollution Prevention Plan (SWPPP)**. The SWPPP should include a site map that shows drainage patterns as well as both existing and proposed buildings, roads, and other features. The SWPPP must also list **Best Management Practices (BMPs)** that will be used to prevent storm water pollution, and

MINIMUM EROSION CONTROL MEASURES FOR SINGLE FAMILY HOME CONSTRUCTION

1. Check with Marin County Planning Department or Flood Control District for creek set-back requirements.
2. During grading phase, track-walk up and down slopes, not parallel.
3. Stabilize site entrance and temporary driveway with 3" crushed rock up to 50' to prevent tracking soil off site.
4. Install straw wattles along contour at or >2:1 slope, keyed into ground at least 3" deep (25 to 50' apart).
5. Install silt fence as secondary measure along contours to keep sediment onsite and to minimize vehicle and foot traffic beyond limits of site disturbance.
6. Install erosion blankets on any disturbed area at or > 2:1 slope.
7. Construct a concrete washout site adjacent to stabilized entrance. Clean as needed and remove at end of project.
8. Cover all stockpiles and landscape materials, keep behind silt fence, and away from water bodies.
9. Use pea-gravel bags around drain inlets located both onsite and within gutter as a last line of defense.
10. Place port-a-potty near stabilized site entrance and away from storm drain inlets and water bodies.
11. Cover all exposed soil with straw or straw/tackifier.

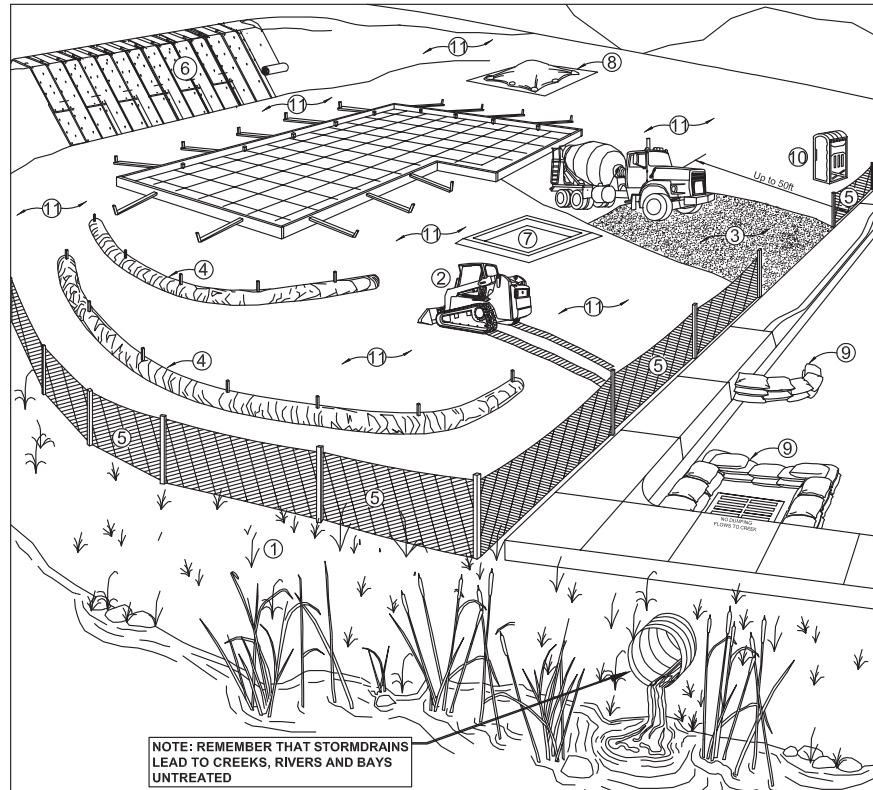

Note: Sediment and erosion control shall be continually maintained throughout the local rainy season and to remain effective during construction phase. Continue inspection and maintenance of BMPs before and after rain events.

From Marin County Stormwater Pollution Prevention Program

identify where they will be used. Chapter 12 includes information on where you can learn more about the General Permit requirements, BMPs and SWPPP preparation.

Here are some common BMPs that apply to many construction sites. Remember that you need to find and use BMPs that specifically address potential pollution generated by work on your site.

Educate your construction workers.

Explain to your workers why clean water is important and what actions you are taking to keep sediment and other pollutants out of storm drains and waterways. Ask them for their help and their ideas.

Schedule construction activities during dry weather.

Construction that moves soil, disturbs vegetative cover or requires use of unsurfaced roads should be completed before the winter rainy season; in northern coastal California, October 15 is the standard date used to mark the official end of dry weather. Large earth-moving projects should be scheduled between April 15 and October 15. If unfinished work needs to be held over until spring, exposed soil must be protected and sediment trapped before leaving the site.

Be ready for rain.

Check the weather forecast and make sure you have all of the materials you need to quickly protect your site.

Protect existing vegetation. Plant more.

Wherever possible, plants already growing on the site should be spared, unless the cleared area is to be immediately replanted or landscaped. Even then, be cautious about removing vegetation. It may take many years for new plantings to duplicate the character and sturdy root systems of the on-site trees and shrubs. Thinning groves of mature trees, especially on ridgetops, may make the remaining trees more susceptible to windthrow. And remember that changing vegetation changes the wildlife use of an area. If you have grown to enjoy the flocks of warblers migrating through your new piece of property every fall, don't expect them to return after you have removed all the undergrowth.

Where construction calls for mass disturbance of wildland vegetation, such as large cut and fill slopes, the native plant community should be

restored through revegetation. Large-scale revegetation projects differ from home or commercial landscaping in that the plants receive minimal maintenance. The area is overplanted with the expectation that some of the plants will die. Plants are grown from seeds or cuttings collected on or near the construction site so that they will be well-adapted to specific soil and weather conditions at the site and thus have a better chance of surviving. Since it takes one to two years to grow a plant big enough to install, revegetation projects should be planned well in advance of actual construction.

Protect bare areas and spoils piles with seed, mulch or plastic sheeting.

All bare soil, including temporary spoils piles, should be protected well before the rains begin. Follow the seeding and mulching recommendations in Chapter 5. Annual grains, such as oats and barley, are frequently used as one-time winter cover because they are relatively inexpensive and reseed poorly. “Re-Green”, a sterile wheat, is available through some local suppliers. Hydroseeding, a mechanical process of applying a slurry of seed, fertilizer, mulch and a tackifier, is useful for establishing grass cover on slopes. Erosion control blankets should be installed on any slopes greater than 2:1.

Install silt fence and straw wattles on contour to prevent concentrated flow.

Straw wattles should be buried 3 to 4 inches into the soil and staked every 4 feet. They should be used only on 3:1 or gentler slopes. Silt fences should be trenched 6 inches into the soil, staked every 6 feet, and placed 2-5 feet from the toe of the slope (Sonoma County PRMD). Straw bales have a high failure rate as sediment fences; the straw is better used as mulch on your construction site. Check wattles and silt fences regularly during the winter and repair them if necessary.

Stabilize entrances with crushed rock.

Vehicle wheels carry sediment and other pollutants onto nearby roadways, causing both hazards and pollution.

Protect drainage inlets.

Use gravel bags or straw wattles to trap and filter any polluted water that may escape your site despite your best efforts.



LIVESTOCK AND EROSION

California's grasslands evolved over thousands of years with grazing animals. Many native grasses and wildflowers depend on regular grazing for fertilization, keeping competing plants in check, and removing dead thatch. The net impact of prehistoric grazing was to keep rangeland vegetation healthy and soils alive and permeable. This harmony has been challenged by the replacement of native grasses and forbs with introduced annual species, the confinement of large numbers of animals in fenced pastures, and the complete removal of grazing from some grassland areas. Grazing management is the art and science of using animals to produce and sustain desired range conditions. Ranchers and range managers for public lands can use different types of livestock, fencing, water development, seeding and other tools to maintain healthy, productive grasslands and reduce erosion.

Horses, sheep, cattle and other livestock can affect erosion in many ways. Concentrated in a small area, livestock can completely denude the soil surface, exposing it to sheet and rill erosion. The weight of the animals can compact the soil to concrete-like hardness, which in turn increases the speed of runoff and activates gully and streambank erosion lower in the watershed. Compaction can also occur in large pastures if the land has been heavily grazed for many years.

Livestock change the vegetation by selectively eating certain species, giving other hardier, less-palatable plants room to flourish. Some plants, such as oak seedlings, may eventually die from repeated browsing. Larger animals can cause mechanical damage to stream and gully banks by walking on them and crushing or eating the new vegetation that might stabilize the banks. On the other hand, livestock can also be used to restore and maintain plant vigor in grasslands, thereby reducing runoff rates and resulting erosion. They reduce thatch, the mass of dead leaves, that impedes new growth and stifles wildflowers. They

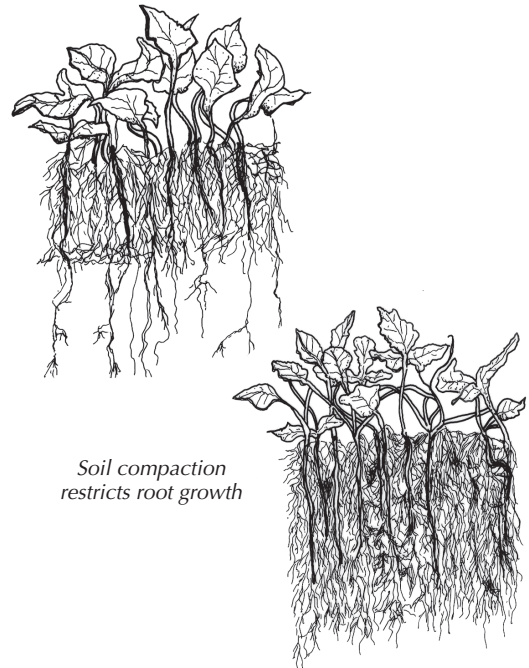

can fertilize and gently disturb soil to create seed beds, and weed out undesirable species.

Several excellent range management resources are identified in Chapter 13, including a new grazing handbook produced for the Sotoyome Resource Conservation District (reference #41) and riparian grazing management guidelines from the Marin Resource Conservation District (reference #40). NRCS and UC Cooperative Extension also offer information and site specific recommendations.

Following are some ideas and tools to reduce erosion caused by livestock:

Protect riparian areas

Riparian zones are the vegetated areas along streams, rivers and lakes. They are extremely valuable to many wildlife species because they provide a safe transition between water and upland areas as well as a rich food supply and plentiful cover. Healthy riparian habitat cools water and captures nutrients and pollutants before they wash away. Riparian zones are particularly vulnerable to livestock induced erosion.

Animals can break down bank stability, damage or destroy plants that hold soil in place, and help deliver sediment directly into streams. Ranchers and land managers can protect stream areas in several ways.

Exclusion fences keep livestock out of the riparian zone all or most of the time. They should be built with gates in case livestock, often calves or lambs, get trapped inside. Exclusions require minimal livestock management, although they often require regular management of invasive weeds or over-exuberant willow growth. They offer the best protection for re-establishing native riparian trees and shrubs.



Riparian Fencing

Exclusion fences can present formidable challenges for livestock managers. Since the animals can no longer drink from the creek, alternative water sources must be developed. Bridges or protected cattle crossings may be needed to move livestock and ranch vehicles. In large floodplains, fences may wash out every few years unless they are placed so far from the stream that the rancher loses the use of large areas of highly-productive land.

Riparian pastures are designed to allow carefully-managed grazing within the riparian zone. Fences can be set farther back from the channel to give the stream room to evolve. Clear goals must be established to make riparian pastures work as both grazing land and stream protection. Regular monitoring should be conducted to modify the grazing prescription as needed to meet the goals. If planting is included, livestock should be kept out for at least three years to give the plants time to become firmly established. For planting within either exclusions or riparian pastures, consider leaving an un-planted strip along the fence to allow vehicle access inside the fence and to discourage livestock from pushing against the fence, thereby weakening it, while browsing on low branches.

The size of a riparian pasture varies with the topography and other landscape features, and the planned use. The Sotoyome RCD's Grazing Handbook states that, "Ideally, riparian pastures should be of a size that will allow the herd to make use of available forage over a few days, allowing ample regrowth of vegetation between grazing periods" (Reference #41). Determining the best times to allow grazing depends on the value of the forage, the stability of the bank and the needs of riparian wildlife. Point Reyes Bird Observatory recommends avoiding grazing during the nesting season which can last from mid-March through late July (Reference #45.)

Cross-fencing creates pastures perpendicular to the stream. Some pastures can be rested while others are grazed. Although this system does not create the level of protection of either exclusion fencing or riparian pastures, it can be a useful tool when alternative water sources are not available and when intensive grazing management is practiced.

Provide alternate water and salt sources.

Increasing the number of places where livestock have access to water and salt spreads them over the available range and reduces the compaction and overgrazing near existing water sources.



Seed and fertilize pastures. Use no-till and minimum-till cultivation.

Increasing the quality and density of vegetation will slow runoff, allowing it to percolate down to replenish groundwater supplies, and reduce sheet and rill erosion. In no-till cultivation of hay and silage crops, the new seed is planted through the old stubble. The land is not plowed, and therefore the soil is never exposed to winter rains. A special seed drill is used that injects the seed and fertilizer all at one time. The field is lightly plowed in minimum-till cultivation, enough to break the soil but not to remove all the stubble. With either method, the field may occasionally have to be clean-tilled, with all stubble plowed in, for weed control. Detailed information is available from NRCS.

No-till and minimum-till cultivation are highly recommended for sloped fields, especially those with recurring rill erosion. Sheet and rill erosion can be deceiving. A quarter inch of soil lost evenly over a 40-acre field yields 900 tons of earth washed into the nearest stream.

Modify your grazing.

Grazing programs manipulate the number of animals in a given area, how long and when they graze there, and the amount of forage and available water to provide maximum, sustainable use of the land. Most grazing systems require fencing and regular rotation of livestock from pasture to pasture. Some call for an even distribution of animals over the range; some call for the intense use of small areas of land for a short time. The best grazing management combines scientific research with the landowner's own specific knowledge and needs. Resources for more information are listed in Chapters 12 and 13.

Separate clean runoff from contaminated runoff.

Clean storm water should be captured and diverted around barns, manure storage areas, paddocks and other areas that produce sediment and/or manure laden water. Roof gutters and downspouts should be installed and maintained on agricultural buildings. In heavily used dairy paddocks, consider using covered loafing barns.

Grass-lined swales, berms and surface drains can be used to collect and divert clean water. Always make sure to deliver and dissipate the captured water to a safe, non-erodible place such as a low-gradient, grassy area.

Locate paddocks away from streams and steep slopes.

Keep horses and other confined animals well away from streams. Even small, ephemeral channels should be protected with grass buffers as they pick up nutrients, pathogens and sediment during rainfall and carry them downstream. Where possible, also keep confined animals off steep hillsides.

Use vegetation to slow and filter runoff.

Maintain well-vegetated buffer strips between horse paddocks, along unsurfaced roads and parking areas, around manure and soiled bedding storage areas, and adjacent to wetlands and natural drainages. Vegetation filters sediment, absorbs nutrients and allows soil bacteria to break down many toxins. In perennial and seasonal streams, trees and shrubs along with grass and understory plants should be used to provide shade, bank stability and wildlife habitat. For ephemeral streams and other areas, grass is an excellent filter. See Chapter 5 for planting guidelines.

Keep confined-animal paddocks dry and well-drained.

Protecting paddock surfaces with sand, wood chips or other porous materials keeps the soil in place. Fibar®, an engineered wood product placed over geotextile fabric, has been used successfully in west Marin County paddocks to keep horses out of the mud without getting stuck in their feet.



Horse paddocks separated from vegetated swale.



LANDSLIDES



In Marin County, small rotational slumps often occur in droves after unusually severe storms and typically stabilize and revegetate by themselves within a few years. Larger landslides are not so readily resolved. Although they are notoriously difficult to predict or repair, there are ways to at least not make them worse.

- No construction should occur on known landslides. If you have any doubts, contact a registered geologist or a geotechnical engineer.
- Runoff from roads, roofs, or any other surfaces should never be directed to a known slide area.
- Existing dirt roads that are cut into landslides should be outsloped or better yet, reshaped to the original contour, seeded, and abandoned. (See Chapter 6 on road erosion.) We strongly recommend that you get professional help before making any alterations to road drainage through landslides.
- Existing vegetation should be left undisturbed.



WILDLIFE

Halting gullies and repairing road washouts do more than keep soil on the ground and out of our waterways—erosion control helps wildlife in both immediate and long-term ways. Examples of quick benefits include the creation of a woody oasis for birds a couple of years after planting willows in a pasture gully, and the instant shade and protection from predators provided for fish by Large Woody Debris.

Long-term soil stabilization has slower but even more important effects on wild animals. Point Reyes Bird Observatory reports that the number of birds in riparian fencing and revegetation projects in Marin and Sonoma Counties grows from just a few species to over 20 species in 10 to 15 years (California Partners in Flight, 2006). Many of these species are neotropical songbirds that breed in North America and migrate to Central and South America during the winter. Although common in the recent past, many are now seriously threatened by habitat destruction in all parts of their range.

Sediment reduction has been a key factor in steelhead and coho salmon recovery strategies throughout coastal California. After a population crash in the 1970s and 80s, Lagunitas Creek now has one of California's largest coho runs. Although research is still being conducted to better understand their recovery and what they need to



California red-legged frog

continue to thrive, twenty years of concerted attention to reducing fine sediments in Lagunitas Creek and its major tributaries has undoubtedly contributed to the coho's success.

Salmonids are vulnerable to excessive sedimentation at many phases of their life cycles. Fine particles in spawning beds

COMMON RIPARIAN BIRDS

Acorn woodpecker • American robin
Anna's hummingbird • belted kingfisher
Bewick's wren • black phoebe
black-headed grosbeak • bushtit
California towhee
chestnut-backed chickadee
common yellowthroat
downy woodpecker • hermit thrush
Nuttall's woodpecker • osprey
Pacific-slope flycatcher • red-shouldered hawk
ruby-crowned kinglet • song sparrow
Swainson's thrush • tree swallow
warbling vireo
Western scrub-jay • Wilson's warbler

Adapted from Bringing the Birds Back: A Guide to Habitat Enhancement in Riparian and Oak Woodlands for the North Bay Region.

SPECIAL-STATUS FISH AND WILDLIFE SPECIES OF MARIN COUNTY*

This list includes animals identified as threatened, endangered and California Species of Concern

tidewater goby	saltmarsh common yellowthroat
coho salmon	tricolored blackbird
steelhead	yellow warbler
chinook salmon	California clapper rail
Tomales roach	California black rail
Myrtle's silverspot butterfly	northern spotted owl
California freshwater shrimp	burrowing owl
California red-legged frog	San Pablo song sparrow
foothill yellow-legged frog	salt-marsh harvest mouse
western pond turtle	Point Reyes mountain beaver
western snowy plover	

*For a complete list of all special-status species occurring in your area, visit the Sacramento Fish and Wildlife Service (www.fws.gov/sacramento) and California Department of Fish and Game ([HYPERLINK "http://www.dfg.ca.gov"](http://www.dfg.ca.gov)).

can reduce the number of eggs that hatch by impeding circulation of oxygen and other nutrients. Larger particles fill in the pools that rearing fish use for shelter and rest. Chronic, long-term sedimentation has reduced estuary volume in many California streams, which in turn affects the timing and duration of sandbar formation. As sandbars remain closed longer into the winter, some salmonids, such as coho who move upstream primarily in December and January, can never enter the stream to spawn.

California red-legged frogs, western pond-turtles, California freshwater shrimp and a host of wetland species from Dungeness crabs to California clapper rails also benefit from controlling accelerated erosion and maintaining healthy, well-functioning watersheds. Many of these species have special federal and/or state protection and cannot be harmed, even as an inadvertent side effect of a restoration or soil stabilization project. If you have questions about whether or not protected species live on your property, contact the California Department of Fish and Game (CDFG). CDFG also maintains an on-line database of species of concern, the California Natural Diversity Database (CNDDDB), that identifies threatened and endangered species observed in specific areas. Chapter 13 includes information on how to access this database.

Fencing our homes often excludes wildlife unnecessarily from theirs. As we move into wildlife corridors, we need to preserve their migration corridors, feeding and resting areas, and access to water. Creating fencing to meet the needs of the landowner and wildlife is possible with a little property evaluation and planning. Depending on your needs (livestock, gardens, or property boundary), simple adjustments to spacing, height, and materials can help create wildlife friendly fencing. For detailed information see Reference #38.

- Property boundaries: Consider using trees and shrubs to create a natural boundary to your property. You will attract wildlife to your area while keeping a distinct property line.
- Livestock fencing: Spacing, height, and fencing materials can accommodate some wildlife and exclude others.
- Exclusion fencing: Try to fence small areas if your goal is to exclude wildlife completely. Fence off a garden or barn as opposed to the entire property to allow animals to pass through the rest of your property.



MAINTENANCE AND MONITORING

All erosion repair and restoration projects require monitoring, and many will require periodic maintenance, especially in the first few years. Monitoring should start before you begin your repair project with clear goals and documentation of the existing conditions. Effectiveness monitoring is making sure that your project is achieving the desired goals. As you check your work in different weather conditions and over several years, you can make adjustments to the repairs, find out which techniques and plants perform best on your site, and note any unintended results, either beneficial or problematic.

Photographic monitoring is an excellent and inexpensive way to track long-term changes. Choose at least two monitoring stations before you begin work and mark them with stakes or GPS. Remember that plants grow—many a photo monitoring station has been consumed by riparian forest after a few years—and select stations that will show your work even with dense vegetation. Take photographs during and after construction, and then periodically thereafter at regular intervals. Taking them at the same time of year will allow you to make more accurate comparisons of changes.

If you are interested in tracking changes in habitat and water quality parameters, check with UC Cooperative Extension, your local RCD, or MCSTOPPP to find out where to get training and equipment (Chapter 13). Some wildlife populations, such as birds and many insects, are relatively easy to monitor while others, such as coho salmon and steelhead, may require special expertise and assistance from the Department of Fish and Game or other agencies. Plant survival and changes in plant composition can be readily monitored with a field guide or two. NRCS and UC Cooperative Extension can help you design a program to monitor range conditions, or lead you to other resources in your area.

Always include time and cost for maintenance when you plan an

erosion control project. Revegetation maintenance is described in Chapter 5 and road maintenance in Chapter 7. Even simple problems, such as tall grass stuck on a fence that diverts water around a headcut repair, can lead to expensive fixes if they are not addressed early.



Before restoration.



A few years after restoration.



PERMITS

Work along creeks or the coast, within riparian and other wildlife habitat, or just about any place where construction activity may potentially affect our common resources requires permits from regulatory agencies. Consultation with agencies should begin as soon as you have a project in mind as the review process can take anywhere from a few weeks to several months after an application is submitted. It is best to start with your local city or county planning department, then move to the regional, state, and federal agencies.

Keep track of communication in writing and ask for copies of your permit applications and letters of authorization as you continue with your project. Some permits require a follow-up visit, monitoring, or a report at the completion of the project. Agencies tend to guide the process along, notifying other agencies or informing landowners about other required permits.

If you are unsure how to obtain regulatory compliance, ask for help. The MCSTOPPP website is a good place to start (<http://www.mcstoppp.org/>). Professional services are available to assist with permit acquisition, which may be a good idea, especially with more complex projects. The list below offers an overview of the major regulatory requirements in California, although there may be additional regulations and local or regional permits that apply to your project.

Marin County has monthly project coordination meetings to review and guide projects. These meetings are attended by representatives from the regulatory agencies to streamline the permit process. Landowners may present their projects (bring photos, sketches, or conceptual plans) to receive feedback from the regulators. To be added to the agenda, call Marla Lafer, San Francisco Regional Water Quality Control Board at (510) 622-2348 or Liz Lewis, Marin County Public Works at (415) 499-7226.

Projects in the San Francisco Bay Area further benefit from another streamlined process known as the Joint Aquatic Resource Permit

Application (JARPA). The JARPA allows applicants to apply for permits to many state and federal agencies with one application. The San Francisco Estuary Project oversees the JARPA form (510) 622-2315.

<http://sfep.abag.ca.gov/projects/JARPA/JARPA.html>

County and City Public Works and Planning Departments:

These are good starting places to find out about local regulations and permits. They are also good sources of aerial photographs, resource inventories and maps, regional know-how and references for additional information.

Marin County Public Works (415) 499-6528

<http://www.co.marin.ca.us/depts/PW/Main/index.cfm>

Sonoma County Permit and Resource Management Department:
(707) 565-1900

<http://www.sonoma-county.org/prmd/>

Regional Water Quality Control Board (RWQCB) §401 Certifications under California Environmental Quality Act (CEQA):

RWQCB §401 certifications regulate projects that may result in a pollutant discharge to a water body. Discharges are not limited to typical construction materials; they also include sediment in the form of dust, mud, and silt. The RWQCB has the right to authorize, waive, or deny projects in order to protect the State's waterbodies. Whenever a §404 permit is needed from the U.S. Army Corps of Engineers, a §401 certification is also required.

San Francisco Bay Region (510) 622-2330

<http://www.waterboards.ca.gov/sanfranciscobay/>

California Department of Fish and Game (CDFG) §1602 Streambed Alteration Agreement under California Environmental Quality Act (CEQA):

Under §1600 et seq. of the California Fish and Game Code, CDFG has jurisdiction over any activity in a creek or river where an existing fish or wildlife resource exists or where such resources derive benefit. Projects affecting or potentially affecting fish and wildlife must obtain an agreement from CDFG, which usually imposes conditions to protect the environment. Project areas with special status (endangered, threatened, or rare) species require additional protection measures. The CDFG web-

site provides access to information about special status species through the California Natural Diversity Database (CNDDDB) USGS quad maps. These maps provide general information for a regional area and are a starting point for researching protected species.

State Headquarters: (916) 445-0411
Bay Delta Region 3: (707) 944-5500
<http://www.dfg.ca.gov/1600/>
<http://www.dfg.ca.gov/whdab/html/cnddb.html>

State Water Resources Control Board, Division of Water Quality:

Compliance with the National Pollutant Discharge Elimination System (NPDES) of the Clean Water Act requires a permit for stormwater discharges associated with construction activity. Construction activity does not include routine maintenance to re-establish original line and grade, hydraulic capacity, or original purpose of a facility, nor does it apply to emergency construction activities required to protect public health and safety. For construction projects disturbing an area greater than one acre, a Notice of Intent (NOI) must be filed and a Stormwater Pollution Prevention Plan (SWPPP) must be prepared and kept onsite. The SWPPP is used to determine the scope of the construction activity and identify Best Management Practices (BMPs) to prevent pollutants from entering stormwater.

State Water Resources Control Board General Line (916) 341-5250
Division of Water Quality (916) 341-5536
<http://www.waterboards.ca.gov/stormwtr/construction.html>

State Water Resources Control Board, Division of Water Rights:

The Division of Water Rights (DWR) has the authority to issue water rights appropriations or registrations to landowners for a variety of projects, including small reservoirs. DWR regulates water licenses for water taken from a surface or underground flow as well as the storage of the water.

Division of Water Rights (916) 341-5300
<http://www.waterrights.ca.gov/forms/>

California Coastal Commission (CCC): San Francisco Bay Conservation and Development Commission (BCDC):

Work in coastal water bodies requires additional authorization. BCDC jurisdiction includes all of San Francisco Bay, defined to include lands within the first 100 feet inland from the shoreline, including some tributaries.

BCDC regulates a variety of actions that include construction, remodeling, or repair of a structure, grading or subdivision of property, substantial change in use of a property, dredging, or the placement of solid material in the bay. In addition, the CCC requires a permit for development within the coastal zone. Your local planning office should be able to assist with coastal zone permits.

Bay Conservation and Development Commission (415) 352-3600
<http://www.bcdc.ca.gov/>

California Coastal Commission Headquarters (415) 904-5200
<http://www.coastal.ca.gov/cdp/cdp-forms.html>

U.S. Army Corps of Engineers §404 Permits under National Environmental Policy Act (NEPA) and the Clean Water Act:

The Corps regulates the release of dredged or fill material to any channel or tributary to a channel that is a navigable water of the US or that has real or potential interstate commerce value. Discharges include sediment or rock as well as other pollutants. By definition, a channel is a watercourse with a bed and bank and an ordinary high water mark. While our creeks are often not considered navigable waters, they mostly drain to navigable waters (including San Francisco, San Pablo and Tomales Bays), resulting in a need for consultation with the Corps.

Army Corps of Engineers San Francisco District Office (415) 977-8659
<http://www.spn.usace.army.mil/>

National Oceanic and Atmospheric Administration (NOAA) Fisheries:

NOAA requires permits for activities affecting threatened and endangered marine and anadromous fish species under the Endangered Species Act.

U.S. Fish and Wildlife Service (USFWS):

The USFWS, part of the Department of the Interior, requires permits for activities affecting threatened and endangered fish and wildlife species under the Endangered Species Act.

With such a daunting list of potential regulations that may affect your project, landowners may be tempted to work without the benefit of permits. Don't do it! Violators incur fines for illegal work, must repair work to satisfy regulators, and may be required to mediate for damage done to the environment.



WHERE TO GET MORE HELP

ORGANIZATIONS

The following organizations provide information and, in some cases, on-site assistance with identifying and repairing erosion problems.

County and City Public Works and Planning Departments:

These are good starting places to find out about local regulations and permits. They are also good sources of aerial photographs, resource inventories and maps, regional know-how and references for additional information.

Marin County Public Works:

(415) 499-6528

<http://www.co.marin.ca.us/depts/PW/Main/index.cfm>

Sonoma County Permit and Resource Management Department:

(707) 565-1900

<http://www.sonoma-county.org/prmd/>

Marin County Stormwater Pollution Prevention Program:

Marin County's website has information for streams and stormwater-related issues with resources and links for local and general use.

(415) 499-6528

<http://www.mcstoppp.org/>

Resource Conservation Districts:

Most California counties have one or more RCDs that offer assistance to agricultural landowners for projects

that benefit water and soil resources. RCDs often fund watershed-wide studies and individual landowner projects in cooperation with many local, state, and federal agencies.

Marin and Sonoma County RCDs:

<http://www.sonomamarinrcds.org/>

Marin RCD (415) 663-1170

Southern Sonoma RCD (707) 794-1242

Sotoyome RCD (707) 569-1448

Gold Ridge RCD (707) 874-2907

East and West Lake RCD (707) 263-4180

Mendocino County RCD (707) 468-9223

California Association of RCDs: <http://www.carcd.org/>

USDA Natural Resources Conservation Service (NRCS):

NRCS can provide technical specifications; information about possible financial assistance from government cost-sharing programs; soils information; on-site advice on selecting an appropriate repair; and help with finding a contractor, consultant or unusual materials. They usually have well-stocked libraries of their own publications and other erosion control references. Local offices have available to them geologists, engineers, wildlife biologists, agronomists and a host of other specialists at the service of the public.

(707) 794-1242, Petaluma Field Office

<http://www.nrcs.usda.gov/>

**University of California Cooperative Extension (UCCE)
University of California's Agriculture and Natural
Resources Department:**

UCCE offers a wealth of research and expertise to the public. They have offices in most counties with advisors for farms, 4-H, nutrition, family and consumer sciences. Master Gardeners are available to assist with gardening, plant resources, and pest control. Extension staff make site visits to help with specific problems, offer financial assistance, and extensive libraries for the public.

(415) 499-4204, Marin
(707) 526-6797, Sonoma
<http://ucanr.org/index.cfm>

California Division of Mines and Geology:

This group offers a goldmine of maps and reports on landslides and related geological features that both affect and help explain erosion problems. A list of publications and prices is available from the Department of Conservation, Division of Mines and Geology, Publications and Information Office, P.O. Box 2980, Sacramento, CA 95812, (916) 445-5716.

Environmental Protection Agency (EPA):

The EPA has a wealth of information pertaining to watersheds on their website. Their non-point source pollution page has background information as well as technical reports and links to additional resources. General Information (Washington DC) (202) 566-1155, Environmental Information Center toll free (866) EPA-WEST

Non-point source: <http://www.epa.gov/owow/nps/categories.html>

General watershed: <http://www.epa.gov/owow/>

FishNet4C: The Fishery Network of the Central California Coastal Counties has a website containing information on local projects in the local area and great links to other helpful sites. Marin County Fishnet Project

(415) 499-7331
<http://fishnet4c.org/index.html>

US Fish and Wildlife Service (USFWS): Also part of the Department of the Interior, USFWS can provide information on threatened and endangered species, and on enhancing and protecting wild animal habitat. (800) 344-WILD

<http://www.fws.gov/>

US Forestry Service (USFS): Another Service of the Department of Agriculture, USFS has done much pioneering research on erosion control methods. They have many fine publications available describing erosion problems and practical ways to fix them.

DC office: (202) 205-8333, Pacific Southwest Region (707) 562-8737

<http://www.fs.fed.us/>

US Geological Survey (USGS): Part of the Department of the Interior, USGS studies and inventories geological and related resources. They have a wealth of maps, aerial photos, infrared photos and many other useful land management tools. California Water Science Center (916) 278-3000, Western Regional Offices (650) 853-8300

<http://www.usgs.gov/>

Russian River Watershed Directory: The Sotoyome RCD has released a directory of useful references for watershed-related work in their district. Many listings extend beyond Sonoma County and could be used to determine what help is available to you. (707) 569-1448

<http://sotoyomercd.org/publications.htm>

SELECTED REFERENCES

The following is by no means an exhaustive list, but it should get you started.

River Science and Management

1. Downs, Peter W. and Kenneth J. Gregory. 2004. *River Channel Management: Towards Sustainable Catchment Hydrosystems*. Oxford University Press.

2. Dunne, Thomas and Luna Leopold. 1978. *Water in Environmental Planning*. W.H. Freeman, Inc.
3. Kansas State Conservation Commission. *Kansas River and Stream Corridor Management Guide*. This well written guide is a wonderful primer on river systems, dynamics, and erosion control. Available free online. <http://www.accesskansas.org/ksc/KSRiversGuide.pdf>
4. Leopold, Luna. 1996. *A View of the River*. Harvard University Press.
5. Leopold, Luna, Gordon Wolman and John Miller. 1964. *Fluvial Processes in Geomorphology*. W.H. Freeman, Inc.
6. Leopold, Luna. 1997. *Water, Rivers and Creeks*. University Science Books.
7. Riley, Ann L. 2003. *A Primer on Stream and River Protection for the Regulator and Program Manager*. Technical Reference Circular W.D. 02-#1. San Francisco Bay Regional Water Quality Control Board. An outstanding and accessible resource for regulators, public land managers and anyone interested in how rivers work and how human development affects natural processes.
8. Riley, Ann L. 1998. *Restoring Streams in Cities: A Guide for Planners, Policymakers, and Citizens*. Island Press.
9. Rosgen, Dave. 1994. *Applied River Morphology*. Wildland Hydrology.
10. **Soil Surveys** of most counties are available from the Natural Resources Conservation Service. These map different soil types and describe their properties in relation to construction, septic systems, plant growth, erodibility, wildlife habitat, recreational use and many other factors.
11. California Department of Fish and Game. 1998 with updated sections. *California Salmonid Stream Habitat Restoration Handbook*. This guide contains background and techniques for those interested in restoration of fish-bearing streams. Written by staff of CDFG, this is the place to begin research for fish-friendly restoration. Available free online or by mail for a shipping charge of \$7. <http://www.dfg.ca.gov/nafwb/manual.html>
12. Eubanks, Ellen and Dexter Meadows. 2002. *A Soil Bioengineering Guide for Streambank and Lakeshore Stabilization*, U.S. Department of Agriculture Forest Service. This stunning guide is an easy to read and detailed guide to streams and bioengineering. Contents include background, planning, and techniques. Available free online. <http://www.fs.fed.us/publications/soil-bio-guide/>
13. Gray, Donald H. and Robbin Sotir. 1996. *Biotechnical and Soil Bioengineering Slope Stabilization: A Practical Guide for Erosion Control*. John Riley and Sons, Inc. New York, NY. Principles, repair considerations, techniques and methods for bioengineered erosion control.
14. Heede, Burchard H. 1976. *Gully Development and Control: The Status of Our Knowledge*. U.S.D.A. Forest Service. Research Paper RM-169. Rocky Mountain Forest and Range Exp. Station, Ft. Collins, CO 80521. This is one of many publications by Heede based on his extensive experiments on repairing gullies. Contains specifications for many types of checkdam.
15. Kraebel, Charles J. and A.F. Pillsbury. 1934. Reissued 1980. *Handbook of Erosion Control in Mountain Meadows*. US Forest Service. Clear, down-to-earth explanations of how gullies grow and how to repair them. Includes specification for willow sprigging, wattling, and brush checkdams.

Erosion and Bioengineering

16. Lowdermilk, W.C. 1953, Revised 1975. *Conquest of the Land through 7000 Years*. USDA Soil Conservation Service, Ag. Info. Bull. No. 99. A delightfully written and fascinating (though sobering) account of how soil erosion has eradicated many ancient cities, and even entire civilizations.
17. Natural Resource Conservation Service (Soil Conservation Service). 1992. *Engineering Field Handbook*. Chapter 16, Streambank and Shoreline and Chapter 18, Soil Bioengineering for Upland Slope Protection and Erosion Reduction are especially useful. Available free online. <http://www.info.usda.gov/CED/ftp/CED/EFH-Ch16.pdf>
<http://www.info.usda.gov/CED/ftp/CED/EFH-Ch18.pdf>
18. Schiechl, Hugo. 1980. *Bioengineering for Land Reclamation and Conservation*. University of Alberta Press, Edmonton, Alberta. A creative and historic look at biotechnical erosion control, full of intriguing methods.

Plants

19. Best, Catherine, et.al. 1996. *A Flora of Sonoma County*. California Native Plant Society.
20. California Native Plant Society:
<http://www.cnps.org/>
21. Faber, Phyllis and Robert F. Holland. 1988. *Common Riparian Plants of California*. Pickleweed Press.
22. Howell, J.T. 1970. *Marin Flora*. University of California Press, Berkeley.
23. Schmidt, Marjorie. 1980. *Growing California Native Plants* University of California Press, Berkeley.
24. *Sunset Western Garden Book*. 1995. Sunset Publishing Corporation.
25. Young, James A. and Cheryl G. Young. 1992. *Seeds of Woody Plants in North America*. Dioscorides Press (an imprint of Timber Press). Detailed text and drawings describing collection, germination, and the planting of woody plants from seed.

Several informative and free booklets available from MCSTOPPP:

26. *Creek Care, A Guide for Urban Marin Residents*.
27. *GO NATIVE, Using Native Plants for Your Yard, Patio, Creek*.
28. *Invasive Weeds of Marin and Sonoma Counties*, by the Marin Sonoma Weed Management Area.

Roads

29. *California Salmonid Stream Habitat Restoration Manual*. See #11
30. FishNet 4C. 2004. *Guidelines for Protecting Aquatic Habitat and Salmon Fisheries for County Road Maintenance*. Written for County and agency roads staff, this resource offers background and BMPs for road maintenance near salmonid habitat.
31. Marin Municipal Water District has developed a Memorandum of Understanding for the maintenance and management of unpaved roads in the Lagunitas Creek Watershed. The focus is to reduce sediment on unpaved roads. Available online. <http://www.marinwater.org/>
32. Weaver, William E, and Danny K. Hagans. *Handbook for Forest and Ranch Roads: A guide for planning, designing, constructing, reconstructing, maintaining and closing wildland roads*. An indispensable resource for constructing and maintaining ranch and fire roads. Available from the Mendocino RCD, <http://mcrd.org/>

New Construction

33. Bay Area Stormwater Management Agencies Association. *Start at the Source: Design Guidance Manual for Stormwater Quality Protection*. This helpful guide suggests various methods for reducing runoff on properties from homes to large industrial complexes. Available free online.
<http://www.basmaa.org/documents/index.cfm?fuseaction=documents&doctypeID=3>
34. CalTrans has extensive information about stormwater best management practices (BMPs) and stormwater pollution prevention plans (SWPPPs) on their website. A SWPPP template is available for public use.
<http://www.dot.ca.gov/hq/construc/stormwater/manuals.htm>
35. San Francisco Regional Water Quality Control Board. 1996. *Erosion and Sediment Control Field Manual*. This manual borrows heavily from the CalTrans BMPs to condense the information and make for a more user-friendly guide.
http://www.informinc.org/cwp2Field_Manual.pdf

Livestock and Erosion

36. Alameda County RCD has a series of fact sheets for horse owners. <http://www.acrcd.org/eqine.html>
37. Anderson, M.K. 2005. *Tending the Wild: Native American Knowledge and the Management of California's Natural Resources*. University of California Press, Berkeley.
38. Buckman, Allan. Wildlife Friendly Fencing Guidelines. Available online.
<http://www.nswg.org/april05fencing.htm>
39. Edwards, S.W. 1992. "Observations on the Prehistory and Ecology of Grazing in California." *Fremontia* 20:3-11
40. Marin Resource Conservation District. 2005. *Managing Riparian Pastures in the Marin Resource Conservation District*.
41. Sotoyome Resource Conservation District. 2006. *Grazing Handbook: A Guide for Resource Managers in Coastal California*. Text by Lisa Bush. Available from the Sotoyome RCD.
<http://sotoyomercd.org/index.html>

Landslides

Contact USGS and NRCS (above) for additional resources. NRCS likely has many of these references in their library.

42. CA Division of Mines and Geology. 1986. *Landslide Hazards in the Southeastern Part of the Petaluma Dairy Belt, Sonoma County, California*. Open File Report 86-5 SF.
43. Huffman, M.E. and C.F. Armstrong. 1980. *Geology for Planning in Sonoma County*, by CA Division of Mines and Geology, Special Report 120.
44. Rice, S.J. and G.B. Chase. 1973. *Geology and Geologic Hazards of the Novato Area, Marin County*, by CA Division of Mines and Geology. Preliminary Report 21.

Wildlife

45. Kreitinger, Kim and Tom Gardali. 2006. *Bringing the Birds Back: A Guide to Habitat Enhancement in Riparian and Oak Woodlands for the North Bay Region*. California Partners in Flight Regional Bird Conservation Plan No. 1.
http://www.prbo.org/calpif/pdfs/north_bay.pdf
46. *Guidelines for Protecting Aquatic Habitat and Salmon Fisheries for County Road Maintenance*. See #30.

47. House, Freeman. 1999. *Totem Salmon: Life Lessons from Another Species*. A beautiful book about the intertwined lives of people and salmon, and the effort to restore the Mattole River. The book ends with, "There is no separate life."
48. Marin Municipal Water District has developed a memorandum of understanding regarding large woody debris in the Lagunitas Creek watershed. The MOU outlines clear, informative language about the benefits of woody debris in creeks. Available online. <http://www.marinwater.org/>
49. Wildlife friendly fencing guidelines. See #38

Several websites offer images and information:

50. American Fisheries Society:
<http://www.afs-calneva.org/>
51. The Audubon Society: <http://www.audubon.org/>
52. Marin Chapter: <http://www.marinaudubon.org/>
53. Madrone (Sonoma County) Chapter:
<http://audubon.sonoma.net/>
54. CalPhotos is a web collection of photos of wild-life, plants, landscape, and people and culture. Photos can be searched by type, name and location making identification a little easier.
<http://calphotos.berkeley.edu/>
55. Northern California Herpetology Society:
<http://www.norcalherp.com/>
56. Point Reyes Bird Observatory: <http://www.prbo.org>
57. SF Bay Area Chapter of The Wildlife Society:
<http://www.tws-west.org/bayarea/index.htm>
58. The Xerces Society for Invertebrate Conservation:
<http://www.xerces.org/>

